



# Avalon<sup>®</sup>

## Radiant Plus Large Insert Owner's Manual

**⚠ WARNING: FIRE OR EXPLOSION HAZARD**

Failure to follow safety warnings exactly could result in serious injury, death, or property damage.

- Do not store or use gasoline or other flammable vapors and liquids in the vicinity of this or any other appliance.
- **WHAT TO DO IF YOU SMELL GAS**
  - Do not try to light any appliance.
  - Do not touch any electrical switch; do not use any phone in your building.
  - Leave the building immediately
  - Immediately call your gas supplier from a neighbor's phone. Follow the gas supplier's instructions.
  - If you cannot reach your gas supplier, call the fire department.
- Installation and service must be performed by a qualified installer, service agency or the gas supplier.



**HOT GLASS WILL CAUSE  
BURNS**

**DO NOT TOUCH GLASS  
UNTIL COOLED**

**NEVER ALLOW CHILDREN  
TO TOUCH GLASS**

**A barrier designed to reduce the risk of burns from the hot viewing glass is provided with this appliance and shall be installed for the protection of children and other at-risk individuals.**

Tested & Listed By  Portland Oregon USA  
OMNI-Test Laboratories, Inc.

**Report # 0028GN101S**  
Omni-Test Laboratories, Inc.  
Portland, Oregon  
ANSI Z21.88-2014  
CSA 2.33-2014

- **Direct Vent Fireplace Insert**
- **Masonry or Factory-Built (Metal) Wood-Burning Fireplace**
- **Residential or Mobile Home**

**This appliance may be installed in an aftermarket, permanently located, manufactured home (USA only) or mobile home, where not prohibited by local codes.**

**This appliance is only for use with the type of gas indicated on the rating plate. A conversion kit is supplied with the appliance.**

**INSTALLER: Leave this manual with the appliance.**

**CONSUMER: Retain this manual for future reference.**



<b><u>Introduction</u></b> .....	<b>2</b>	<b><u>Surround Panel Installation</u></b> .....	<b>20</b>
<b><u>Important Information</u></b> .....	<b>2</b>	<b><u>Glass Frame Removal and Installation</u></b> .....	<b>21</b>
<b><u>Listing Details</u></b> .....	<b>2</b>	<b><u>Glass Frame Removal and Installation</u></b>	
<b><u>Features</u></b> .....	<b>6</b>	<b><u>(continued)</u></b> .....	<b>22</b>
<b><u>Installation Options</u></b> .....	<b>6</b>	<b><u>Face Installation</u></b> .....	<b>23</b>
<b><u>Heating Specifications</u></b> .....	<b>6</b>	<b><u>Log Installation</u></b> .....	<b>24</b>
<b><u>Dimensions</u></b> .....	<b>6</b>	Rock Wool Placement.....	28
<b><u>Electrical Specifications (for optional blower)</u></b>	<b>6</b>	Ember Placement .....	28
<b><u>Fuel</u></b> .....	<b>6</b>	<b><u>Steps for Finalizing the Installation</u></b> .....	<b>29</b>
<b><u>Installation Warnings</u></b> .....	<b>7</b>	Air Shutter Adjustment .....	30
<b><u>Packing List</u></b> .....	<b>7</b>	<b><u>Before You Begin</u></b> .....	<b>31</b>
<b><u>Additional Items Required</u></b> .....	<b>7</b>	<b><u>Location of Controls</u></b> .....	<b>31</b>
<b><u>Order of Installation</u></b> .....	<b>7</b>	<b><u>Starting the Pilot</u></b> .....	<b>32</b>
<b><u>Fireplace Requirements</u></b> .....	<b>8</b>	<b><u>Starting the Heater for the First Time</u></b> .....	<b>32</b>
Factory-Built (Metal) Wood-Burning Fireplace		<b><u>Remote Control Operation</u></b> .....	<b>33</b>
Requirements.....	9	<b><u>Remote Control Operation (continued)</u></b> .....	<b>34</b>
<b><u>Hearth Requirements</u></b> .....	<b>9</b>	<b><u>Remote Control Operation (continued)</u></b> .....	<b>35</b>
<b><u>Leveling Legs</u></b> .....	<b>10</b>	<b><u>Remote Control Operation (continued)</u></b> .....	<b>36</b>
<b><u>Electrical Requirements for Optional Blower</u></b>	<b>10</b>	<b><u>Normal Operating Sounds</u></b> .....	<b>37</b>
<b><u>Clearances</u></b> .....	<b>11</b>	<b><u>Normal Operating Odors</u></b> .....	<b>37</b>
Mantel Requirements.....	11	<b><u>Power Outages</u></b> .....	<b>37</b>
<b><u>Gas Line Requirements</u></b> .....	<b>12</b>	<b><u>Maintaining Your Heater's Appearance</u></b> .....	<b>38</b>
Gas Line Location .....	12	<b><u>Battery Replacement</u></b> .....	<b>38</b>
Gas Inlet Pressure .....	12	<b><u>Yearly Service Procedure</u></b> .....	<b>39</b>
<b><u>Vent Requirements</u></b> .....	<b>13</b>	<b><u>Replacement Parts List</u></b> .....	<b>40</b>
Altitude Considerations .....	13	<b><u>Wiring Diagram</u></b> .....	<b>40</b>
Vent Restrictor .....	14	Safety Label.....	41
Restrictor Adjustment.....	14	<b><u>CONDITIONS &amp; EXCLUSIONS</u></b> .....	<b>42</b>
Vent Installation .....	15	<b><u>IF WARRANTY SERVICE IS NEEDED:</u></b> .....	<b>42</b>
Vent Location .....	15	<b><u>LP (Propane) Conversion Instructions</u></b> .....	<b>43</b>
Vent Configurations .....	16	<b><u>Optional Firebacks</u></b> .....	<b>47</b>
Vent Connector Removal and Installation.....	17		
Vent Connector Removal and Installation			
(continued) .....	18		

- Failure to follow all of the requirements may result in property damage, bodily injury, or even death.

**Young children should be carefully supervised when they are in the same room as the appliance. Toddlers, young children and others may be susceptible to accidental contact burns. A physical barrier is recommended if there are at risk individuals in the house. To restrict access to a fireplace or stove, install an adjustable safety gate to keep toddlers, young children and other at risk individuals out of the room and away from hot surfaces.**

**Children and adults should be alerted to the hazards of high surface temperature and should stay away to avoid burns or clothing ignition. Do not touch the hot surfaces of the heater. Educate all children of the danger of a high-temperature heater.**

**Due to the high temperature, the heater should be located out of traffic and away from furniture and draperies.**

- This unit must be installed by a qualified installer to prevent the possibility of an explosion.
- This appliance must be installed in accordance with all local codes, if any; if not, in U.S.A. follow ANSI Z223.1 and NFPA 54(88), in Canada follow CSA B149.1.
- A manufactured home (USA only) or mobile home OEM installation must conform with the Manufactured Home Construction and Safety Standard, Title 24 CFR, Part 3280, or, when such a standard is not applicable, the Standard for Manufactured Home Installations, ANSI/NCSBCS A225.1, or Standard for Gas Equipped Recreational Vehicles and Mobile Housing, CSA Z240.4. This appliance may be installed in Manufactured Housing only after the home is site located.
- All exhaust gases must be vented outside the structure of the living-area. Combustion air is drawn from outside the living-area structure. The venting must not be connected to a chimney flue serving a separate solid-fuel burning appliance.
- Notify your insurance company before hooking up this fireplace.
- The instructions in this manual must be strictly adhered to. Do not use makeshift methods or compromise in the installation. Improper installation will void the warranty and safety listing.
- This heater is approved for use with natural gas (NG) or propane (LP). Burning the incorrect fuel will void the warranty and safety listing and may cause an extreme safety hazard. Direct questions about the type of fuel used to your dealer.
- Contact your local building officials to obtain a permit and information on any installation restrictions or inspection requirements in your area.
- If the flame becomes sooty, dark orange in color, or extremely tall, do not operate the heater. Call your dealer and arrange for proper servicing.
- It is imperative that control compartments, screens, or circulating air passageways of the heater be kept clean and free of obstructions. These areas provide the air necessary for safe operation.
- Do not operate the heater if it is not operating properly in any fashion or if you are uncertain. Call your dealer for a full explanation of your heater and what to expect.
- Do not store or use gasoline or other flammable liquids in the vicinity of this heater.
- Do not operate if any portion of the heater was submerged in water or if any corrosion occurs. Immediately call a qualified service technician to inspect the appliance and to replace any part of the control system and any gas control which has been under water.

**Safety Warnings (continued)**

- Because this heater can be controlled by a thermostat there is a possibility of the heater turning on and igniting any items placed on or near the appliance.
- Light the heater using the built-in igniter. Do not use matches or any other external device to light your heater.
- Never remove, replace, modify or substitute any part of the heater unless instructions are given in this manual. All other work must be done by a trained technician. Don't modify or replace orifices.
- The viewing glass should be opened only for conducting service.
- Allow the heater to cool before carrying out any maintenance or cleaning.
- Operate the heater according to the instructions included in this manual.
- If the main burners do not start correctly turn the gas off and call your dealer for service.
- This unit is not for use with solid fuel.
- Do not place anything inside the firebox (except the optional artwork).
- **Warning:** Do not operate appliance with the glass front removed, cracked or broken. Replacement of the glass should be done by a licensed or qualified service person.
- Do not throw this manual away. This manual has important operating and maintenance instructions that you will need at a later time. Always follow the instructions in this manual.
- Instruct everyone in the house how to shut gas off to the appliance and at the gas main shutoff valve. The gas main shutoff valve is usually next to the gas meter or propane tank and requires a wrench to shut off.
- A barrier designed to reduce the risk of burns from the hot viewing glass is provided with this appliance and shall be installed for the protection of children and other at-risk individuals.
- If the barrier becomes damaged, the barrier shall be replaced with the manufacturer's barrier for this appliance.
- Clothing or other flammable material should not be placed on or near the appliance.
- Any safety screen, guard, or barrier removed for servicing an appliance must be replaced prior to operating the appliance.
- Installation and repair should be done by a qualified service person. The appliance should be inspected before use and at least annually by a professional service person. More frequent cleaning might be required due to excessive lint from carpeting, bedding material, et cetera. It is imperative that control compartments, burners, and circulating air passageways of the appliance be kept clean.
- **Travis Industries, Inc. grants no warranty, implied or stated, for the installation or maintenance of your heater, and assumes no responsibility of any consequential damage(s).**

**Proposition 65 Warning:** Fuels used in gas, woodburning or oil fired appliances, and the products of combustion of such fuels, contain chemicals known to the State of California to cause cancer, birth defects and other reproductive harm.  
California Health & Safety Code Sec. 25249.6

**Features**

- Works During Power Outages
- Blower Optional
- Standing Pilot
- Remote Programmable Thermostat Included
- Variable-Rate Heat Output

**Installation Options**

- Residential or Mobile Home
- Fireplace Insert
- Masonry or Factory Built (Metal) Wood-Burning Fireplace
- Natural Gas or Propane

**Heating Specifications**

Approximate Heating Capacity (in square feet)\*  
 Maximum BTU Input Per Hour

**Natural Gas**

500-1,650  
 33,000

**Propane**

500-1,650  
 30,000

\* Heating capacity will vary with floor plan, insulation, and outside temperature.

**Dimensions**

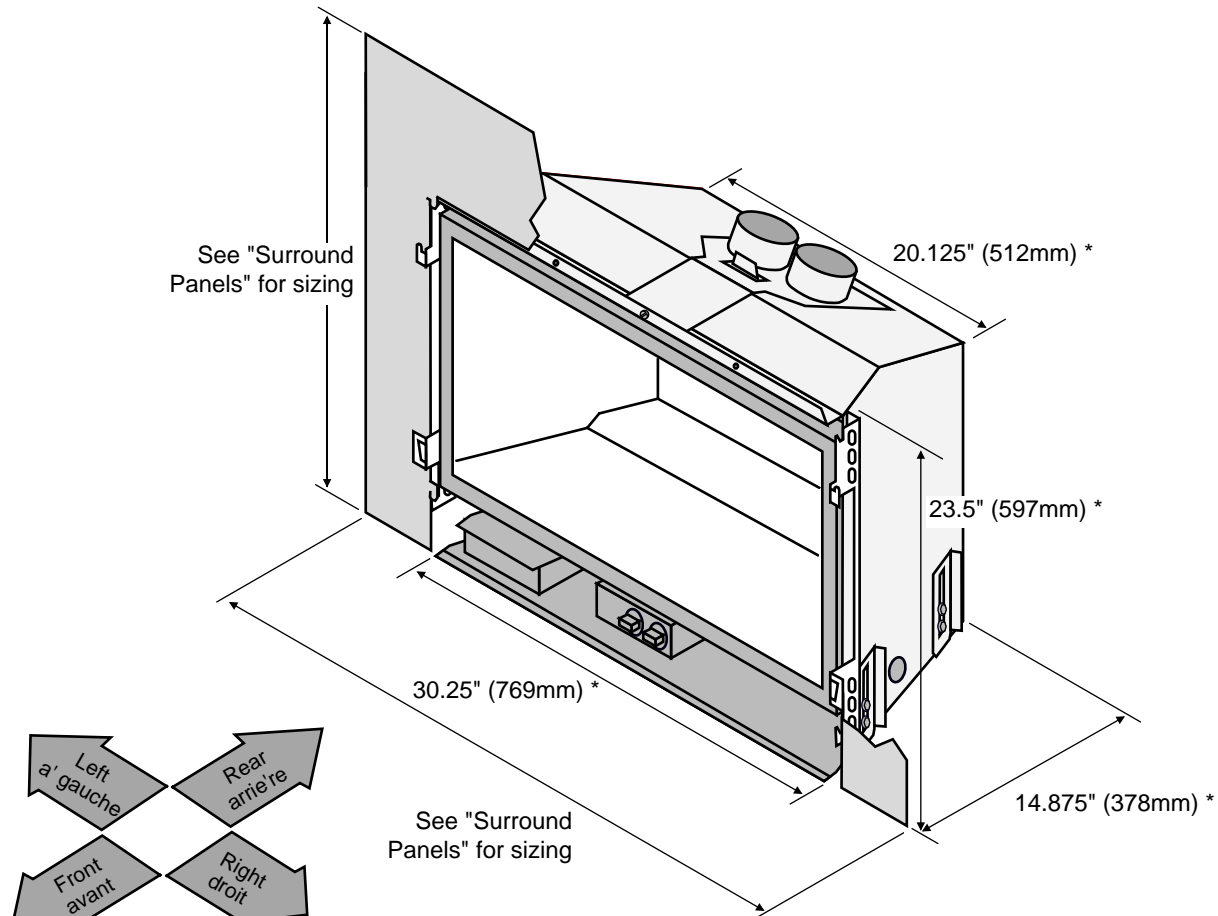

\* See "Fireplace Requirements" for sizing details.

**Electrical Specifications (for optional blower)**

Blower Electrical Rating ..... 120 Volts, 60 Hz, Max. 0.55 Amps

**Fuel**

This heater is shipped in natural gas (NG) configuration but may be converted to use propane (LP) using the included conversion kit.

### ***Installation Warnings***

---

- **Failure to follow all of the requirements may result in property damage, bodily injury, or even death.**
- **This heater must be installed by a qualified installer who has gone through a training program for the installation of direct vent gas appliances.**
- **The installation must conform with local codes or, in the absence of local codes, with the National Fuel Gas Code, ANSI Z223.1/NFPA 54, or the National Gas and Propane Installation Code, CSA B149.1..**
- **In Manufactured or Mobile Homes must conform with Manufactured Home Construction and Safety Standard, Title 24 CFR, Part 3280, or, when such a standard is not applicable, the Standard for Manufactured Home Installations, ANSI/NCSBCS A225.1. This appliance may be installed in Manufactured Housing only after the home is site located.**
- **The heater is designed to operate on natural gas, or propane (LP).**
- **All exhaust gases must be vented outside the structure of the living-area. Combustion air is drawn from outside the living-area structure.**
- **Notify your insurance company before hooking up this heater.**
- **The requirements listed below are divided into sections. All requirements must be met simultaneously. The order of installation is not rigid – the qualified installer should follow the procedure best suited for the installation.**

### ***Packing List***

---

- Propane Conversion Kit
- Log Set (includes embers, rock wool)
- (4) AA Batteries, (2) AAA Batteries
- "Fireplace Altered" tag (attach to the fireplace)
- Remote (thermostatic) with wall holder

### ***Additional Items Required***

---

- Faceplate (surround panel may be needed for certain applications)
- Vent/Intake Equipment (see "Vent Requirements")
- Gas Line Equipment (shutoff valve, pipe, etc.)

### ***Order of Installation***

---

- 1 If the heater is to use propane, install the propane conversion kit (see page 43).
- 2 Install gas line into the fireplace (do not connect to unit).
- 3 Position the heater.
- 4 Connect the gas line and gas vent to the appliance.
- 5 Install the optional surround panels.
- 6 Follow the instructions under "Finalizing the Installation" on page 29.

### Fireplace Requirements

- Insert must be placed within a code-conforming masonry fireplace or tested and listed factory-built (metal) wood-burning fireplace. Repair any fireplace damage prior to installation.
- Because the insert may use an optional circulation blower, clean the fireplace, smoke shelf, and chimney prior to installation.
- This heater may be placed in a bedroom. Please be aware of the large amount of heat this appliance produces when determining a location.

Fireplace Sizing	
(a) Minimum Height	23.75" (604mm)
(b) Minimum Width	31" (788mm)
(c) Minimum Depth	15" (381mm)
(d) Hearth Extension	0" (0mm)

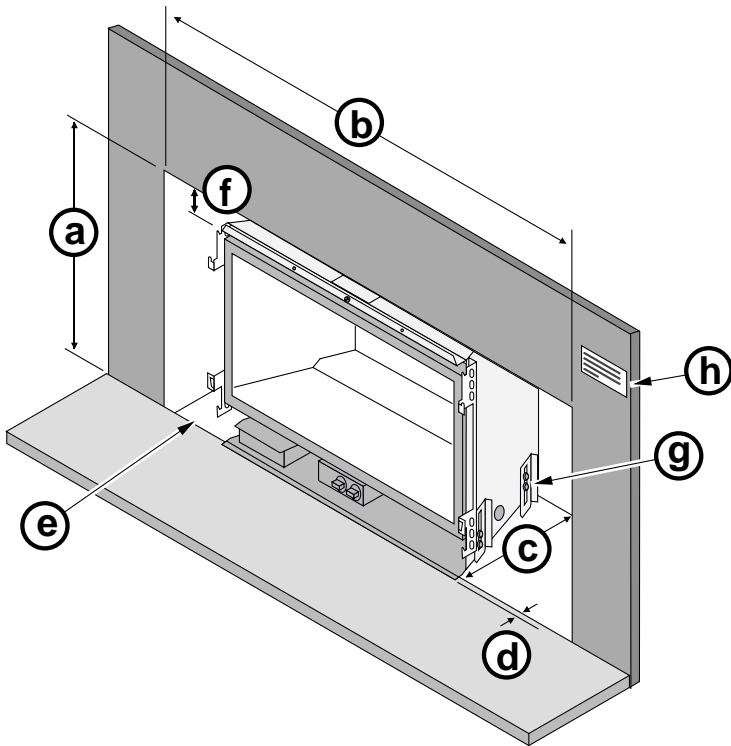

- (e) The gas line should be installed prior to installing the heater.
- (f) For tight fits (under 28") see the section "Removing the Vent Connector"
- (g) See "Leveling Legs" for details on leveling the heater.

- (h) Attach the "This fireplace has been altered..." plate to the fireplace (use two screws or other suitable method). You may wish to place it in a location where it will be covered by the surround panels or face.



## Factory-Built (Metal) Wood-Burning Fireplace Requirements

**NOTE:** Any parts that are removed must be removed in a way that would allow them to be re-installed if the insert is ever removed (removal of rivets or screws is acceptable).

The damper ("A") and grate (with log set) ("B") must be removed (see the illustration below)

The smoke shelf ("C"), internal baffles ("D"), screen ("E"), masonry lining or refractory ("G" & "I"), and metal or glass doors ("F") may be removed (if applicable)

The fireplace must be permanently marked to indicate that it has been altered and is no longer suitable for burning solid fuel (wood), unless the removed parts are re-installed. Cutting of any sheet metal parts is prohibited.

The insulation ("H"), and any structured rigid frame members must not be removed or altered (side and top of door frame, side and top of the face of the fireplace, metal sides, etc.).

The metal floor ("J") of the firebox may be removed in certain cases\*.

The surround panels should not seal ventilation openings on the fireplace.

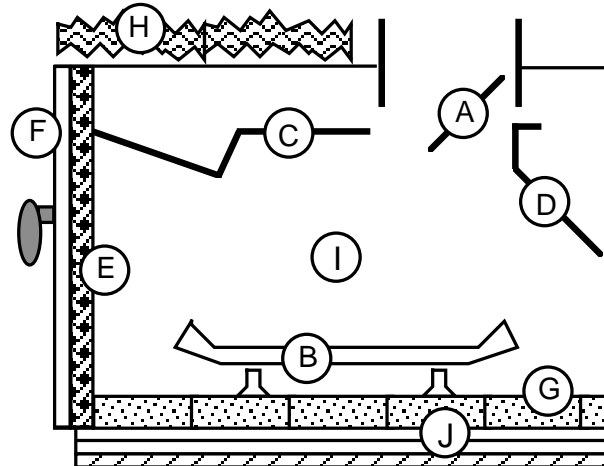

**\*CAUTION:** Firebox floor removal is not covered under the appliance safety standard (ANSI Z21.88 CSA 2.33) used in the safety certification of this appliance. The safety certification does not apply to this method of installation. Before installing the appliance using this method, contact the Authority Having Jurisdiction to determine if this installation is acceptable in your area. The sheet metal base of the fireplace must be left in place.

If the factory-built fireplace has no gas access hole(s) provided, an access hole of 1.5 inch (37.5 mm) or less may be drilled through the lower sides or bottom of the firebox in a proper workmanship like manner. This access hole must be plugged with non-combustible insulation after the gas supply line has been installed.

## Hearth Requirements

The heater and face must not contact combustible surfaces. A non-combustible hearth extension is not required. However, if the heater is installed next to the floor, we recommend a hearth to protect the flooring surface from discoloration or other negative impact from the heater.

### Leveling Legs

---

This heater includes front and rear leveling legs to accommodate fireplaces with a step-down firebox.

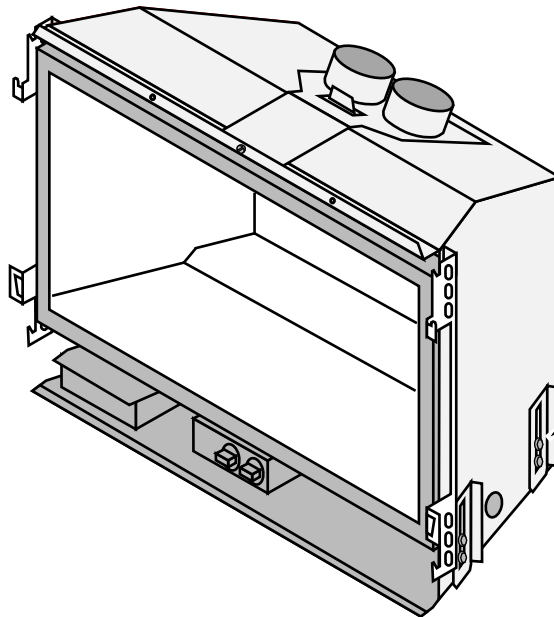

Loosen these bolts, slide the legs to the correct position, then re-tighten the bolts.

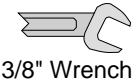

3/8" Wrench

### Electrical Requirements for Optional Blower

---

- Route the power cord out in front of the appliance.
- Plug the power cord into a grounded 120 Volt outlet (do not remove the grounding pin).
- The electrical connection may also be made using the optional Wiring Kit (SKU 97200315).
- The appliance, when installed, must be electrically grounded in accordance with local codes or, in the absence of local codes, with the *National Electrical Code, ANSI/NFPA 70*, or the *Canadian Electrical Code, CSA C22.1*.

## Clearances

Due to the high temperature of the heater, it should be located out of traffic and away from furniture and draperies.

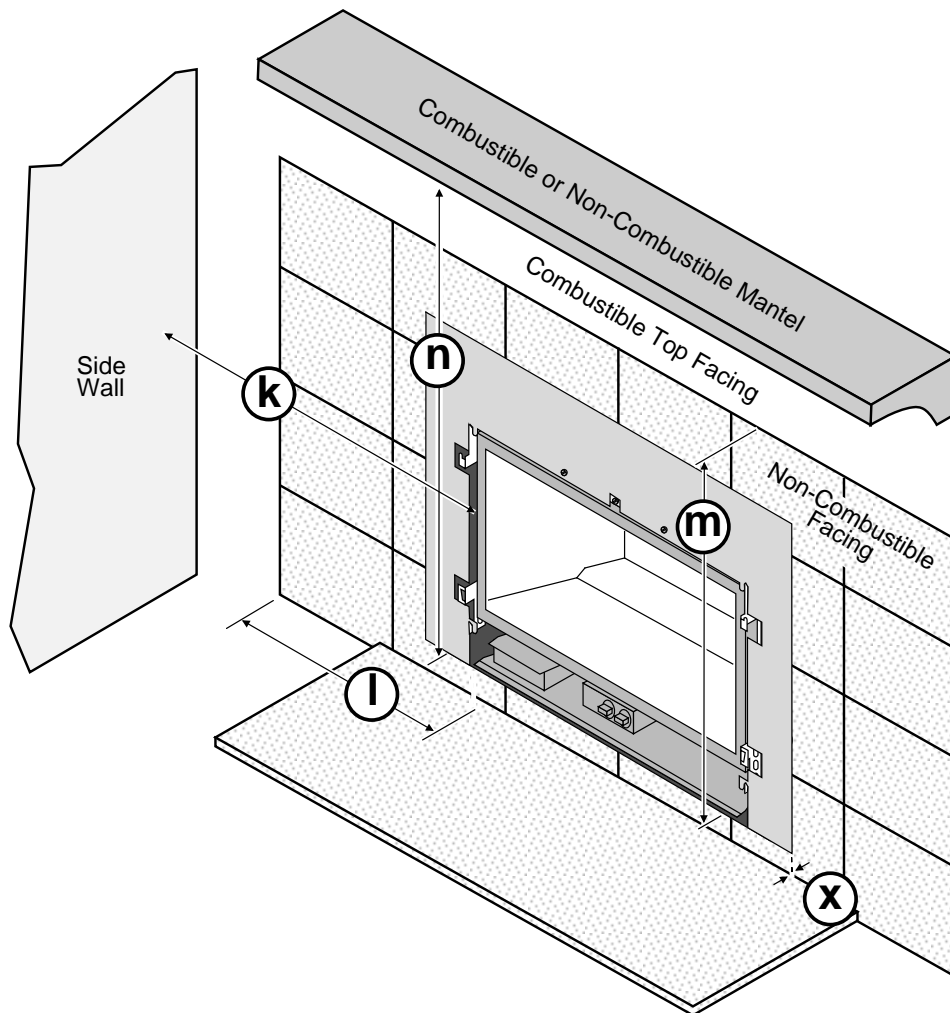

	Minimum Clearances
<b>k Sidewall to Insert</b>	5" (127mm)
<b>l Side Facing (non-combustible)</b>	5" (127mm)
<b>m Top Facing*(non-combustible)</b>	38" (966mm)
<b>n Mantel**(combustible or non-combustible)</b>	36.5" (928mm)
<b>x Hearth Extension</b>	0" (0mm)

\* The non-combustible top facing must extend 38" (966mm) above the base of the insert or to the bottom of the mantel (whichever is less).

\*\* The combustible area above the non-combustible facing must not protrude more than 3/4" (20mm) from the facing. If it does, it is considered a mantel and must meet the mantel requirements listed in this manual.

## Mantel Requirements

The maximum mantel depth is 12" (305mm).

**Gas Line Requirements**

**MASSACHUSETTS INSTALLATIONS - WARNING:**

THIS PRODUCT MUST BE INSTALLED BY A LICENSED PLUMBER OR GAS FITTER WHEN INSTALLED WITHIN THE COMMONWEALTH OF MASSACHUSETTS.

**OTHER MASSACHUSETTS CODE REQUIREMENTS:**

- Flexible connector must not be longer than 36 inches.
- Shutoff valve must be a "T" handle gas cock.
- Only direct vent sealed combustion products are approved for bedrooms or bathrooms.
- Fireplace dampers must be removed or welded in the open position prior to the installation of a fireplace insert or media.
- A carbon monoxide (CO) detector is required in the same room as the appliance.

- The gas line must be installed in accordance with all local codes, if any; if not, follow ANSI 223.1 and the requirements listed below.
- A manual shutoff valve is required within 3' of the heater. It should be placed upstream of the flex line (if used) and may be installed behind the access door inside the heater. .)
- The heater and gas control valve must be disconnected from the gas supply piping during any pressure testing of that system at test pressures in excess of 1/2 psig. For pressures under 1/2 psig, isolate the gas supply piping by closing the manual shutoff valve.
- Leak test all gas line joints and the gas control valve prior to and after starting the heater.
- This heater is designed either for natural gas or for propane (but not for both). Check the sticker on the top of the gas control valve to make sure the correct fuel is used (see illustration on page 4).
- Installation must be performed by a qualified installer, service agency or the gas supplier (In Massachusetts a licensed plumber/gasfitter).

**Gas Line Location**

- The gas inlet accepts a 1/2" MPT.

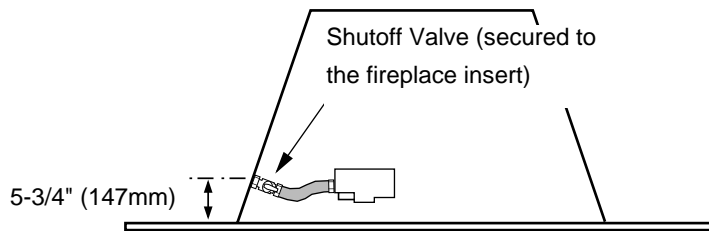

**Gas Inlet Pressure**

	Standard Input Pressure
Natural Gas	7" W.C. (1.74 kPA)
Propane	11" W.C. (2.73 kPA)

- If the pressure is not sufficient, make sure the piping used is large enough, the supply regulator is adequately adjusted, and the total gas load for the residence does not exceed the amount supplied.
- The supply regulator (the regulator that attaches directly to the residence inlet or to the propane tank) should supply gas at the suggested input pressure listed above. Contact the local gas supplier if the regulator is at an improper pressure.

## Vent Requirements

Travis Industries manufactures a vent kit specifically for this insert (sku 96200330). It includes 30' (10M) of vent, hose clamps, and a prairie cap. The flashing on the cap is 18" (458mm) by 18" (458mm).

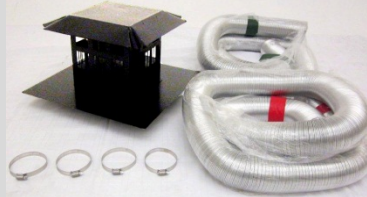

- The gas appliance and vent system must be vented directly to the outside of the building, and never be attached to a chimney serving a separate solid fuel or gas-burning appliance. Each direct vent gas appliance must use its own separate vent system.
- Make sure the exhaust pipe on the heater connects to the exhaust portion of the cap. The illustrations below show how the flex liners should be attached.
- The exhaust vent must reline the entire length of the chimney and terminate above the chimney top.
- Be careful not to crimp or rupture the liner when bending it into chimney offsets.
- When installed, the vent must meet all of the vent manufacturer's requirements.
- Use the following vent:
  - 3" UL 441 or 1777 Gas Liner for Exhaust and Air Inlet
  - Duravent Chimney Liner Termination (use one of the two listed below):
    - Prairie Cap with Flashing (included in kit shown above)
    - 3" & 3" Co-Linear to 6-5/8" Co-Axial Adapter, Flashing, & High-Wind Vertical Cap

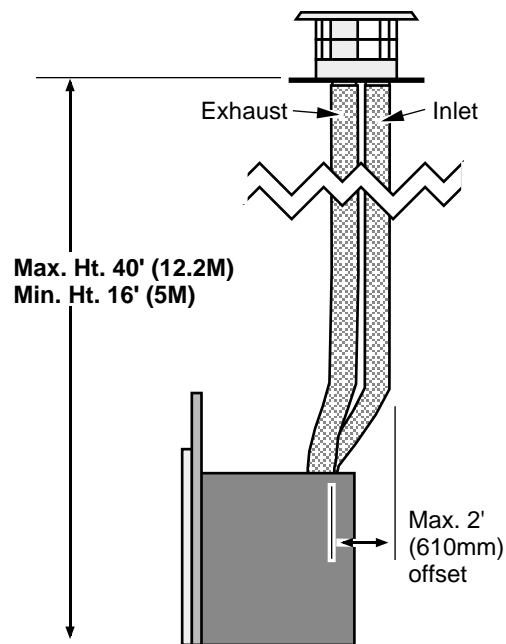

## Altitude Considerations

- This heater has been tested at altitudes ranging from sea level to 6,000 feet (1,800 M). In this testing we have found that the heater, with its standard orifice, burns correctly with just an air shutter adjustment.
- Failure to adjust the air shutter properly may lead to improper combustion which can create a safety hazard. Consult your dealer or installer if you suspect an improperly adjusted air shutter.

## Vent Restrictor

**WARNING: Restrictor adjustment should only be done by a qualified installer.**

Most installations do not require vent restrictor adjustment. Only those installations determined to be over-drafting require adjustment. The best indication of over-drafting is a hyper-active flame pattern (flames move too quickly). This is most common in tall vent configurations. Over-drafting may affect the pilot, but this is **not** the best way to determine over-drafting.

More importantly, **do not over-restrict the insert.** This leads to ghosting or lifting flames, a very unstable condition for both the burner and pilot. Reduce the restrictor setting if this occurs.

If restrictor adjustment is required, make sure to make the adjustment one step at a time. Wait a minimum of 5 minutes after burner ignition to monitor flame quality.

## Restrictor Adjustment

To access the restrictor, remove the baffle at the top of the firebox. Loosen the 4 screws holding it in place, then slide it forward and down to remove.

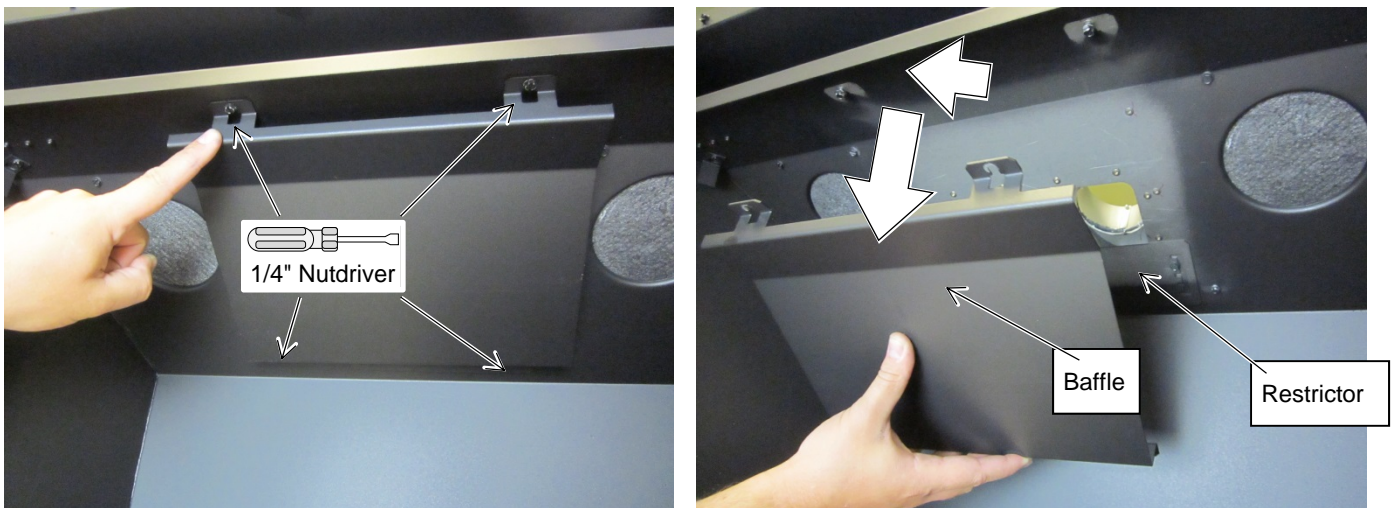

The restrictor is adjusted by loosening the two screws holding it in place. Slide the restrictor until the correct notch falls over the screws and re-tighten. Replace the baffle.

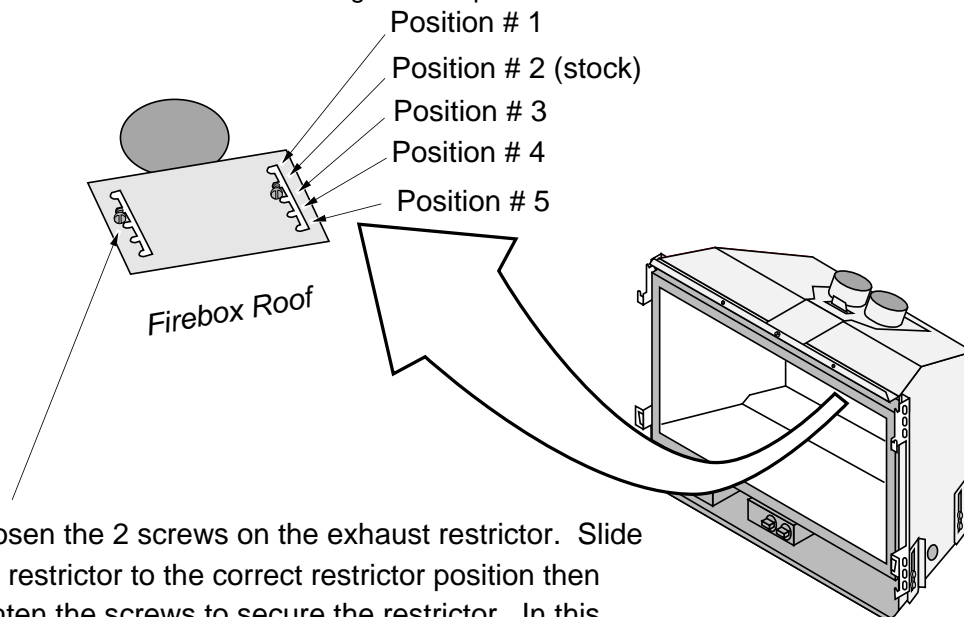

Loosen the 2 screws on the exhaust restrictor. Slide the restrictor to the correct restrictor position then tighten the screws to secure the restrictor. In this illustration, the restrictor in position 2.

## Vent Installation

Secure the vent to the fireplace insert and termination kit using screws.

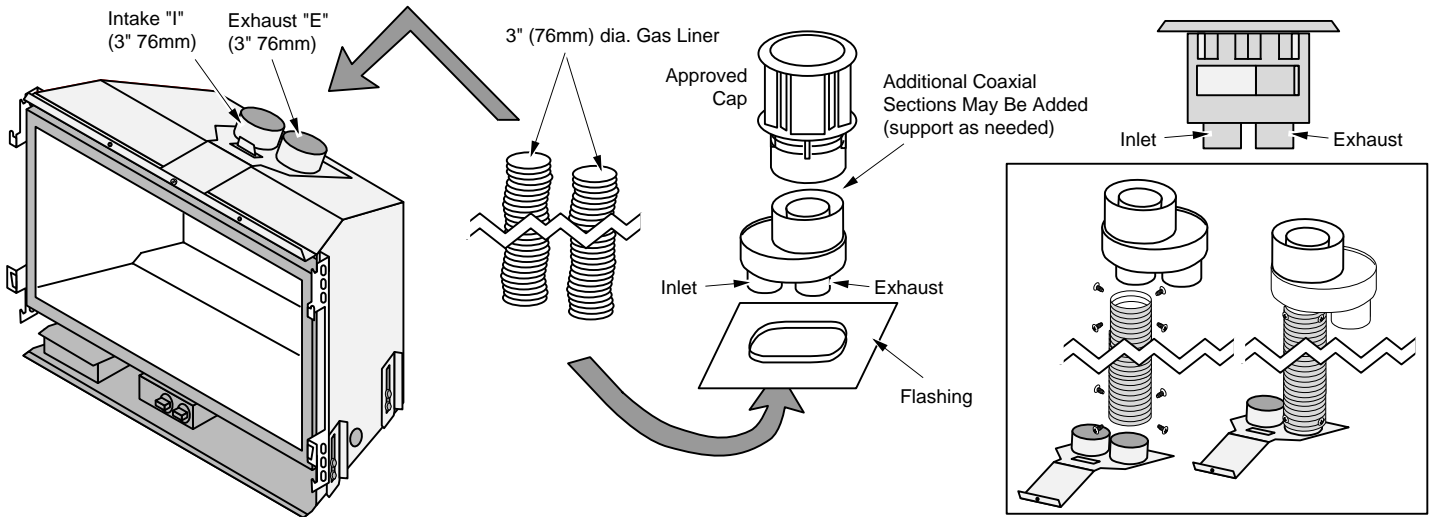

## Vent Location

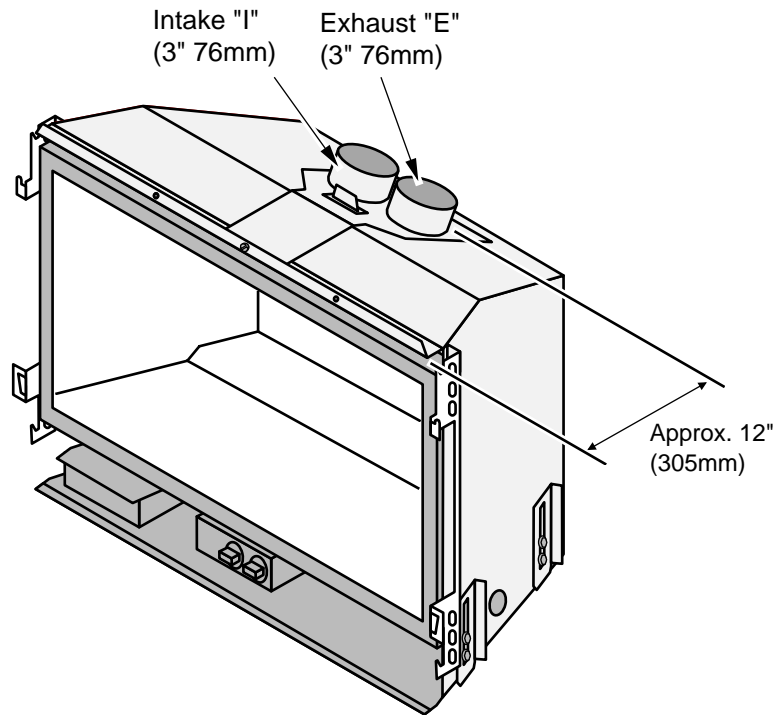

## Vent Configurations

## Inlet &amp; Exhaust Re-Line

## Exhaust Only Re-Line

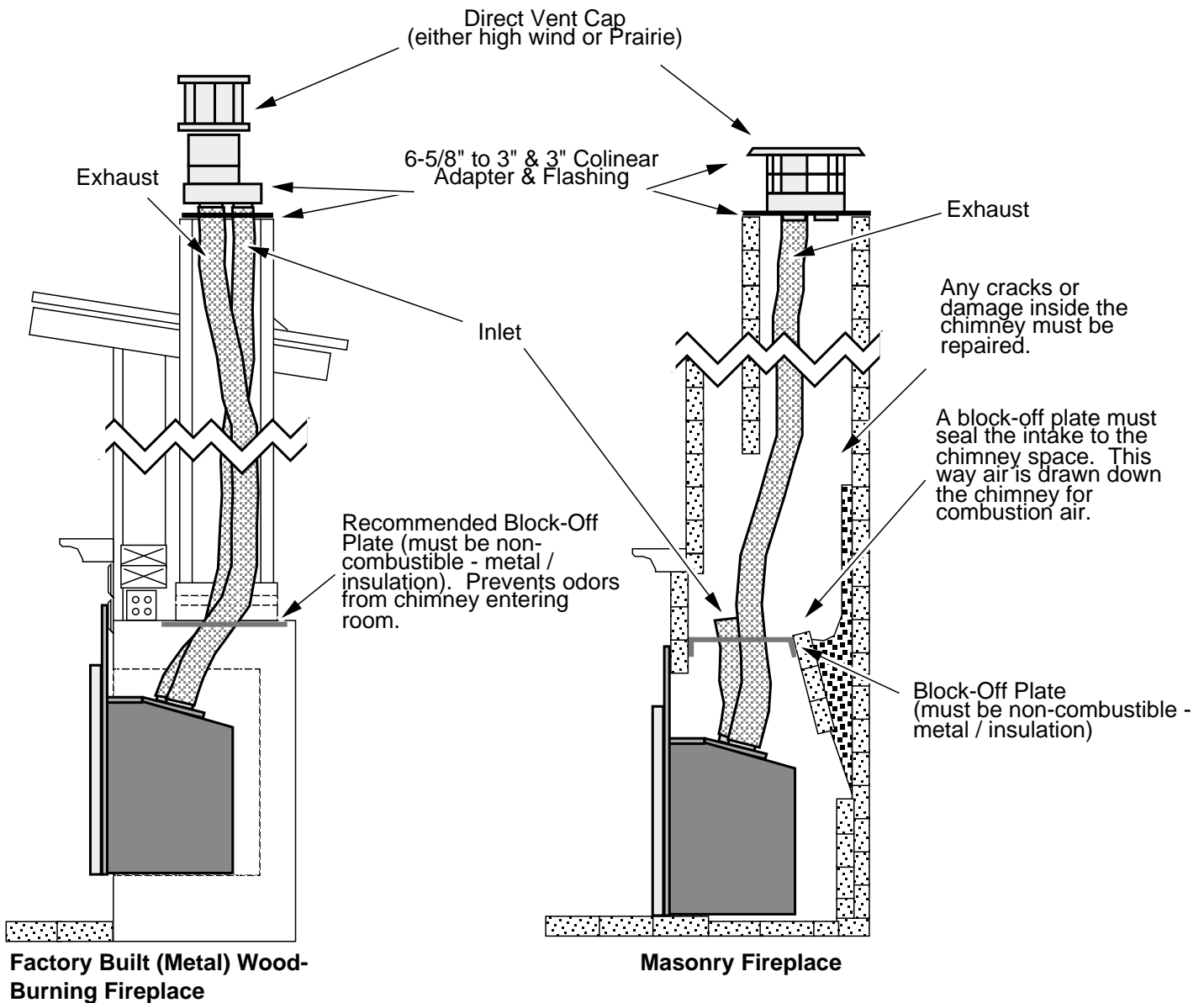

**NOTE:** You may use either re-line configuration with a masonry or zero-clearance fireplace.

**CAUTION:** The "Exhaust Only Re-line" is not covered under the appliance safety standard (ANSI Z21.88 CSA 2.33) used in the safety certification of this appliance. The safety certification does not apply to this installation. Before installing the appliance using this method, contact the Authority Having Jurisdiction to determine if this installation is acceptable in your area. This type of installation requires a minimum chimney cross section of 48 square inches.



### Vent Connector Removal and Installation

- The vent connector is shipped attached to the insert, but may be removed to facilitate tight installations. See the directions below for installation.
1. Route the flex vent through the chimney from above (leave an extra 3' at the top). Make sure the flex is thoroughly stretched.
  2. Remove the vent connector and attach it to the flex vent (see the instructions on the following page).  
NOTE: be careful of the anti-seize on the connector – it will stain clothing, etc.
  3. Pull on the flex vent until the vent connector is at the same height as the insert. Temporarily attach the flex vent to the top of the chimney (leave extra slack).
  4. Slide the insert into place, guiding the vent connector into the guides on top of the insert.
  5. Attach the vent connector to the appliance (see the following page for details).
  6. Remove any excess slack in the flex line and attach the vent termination.

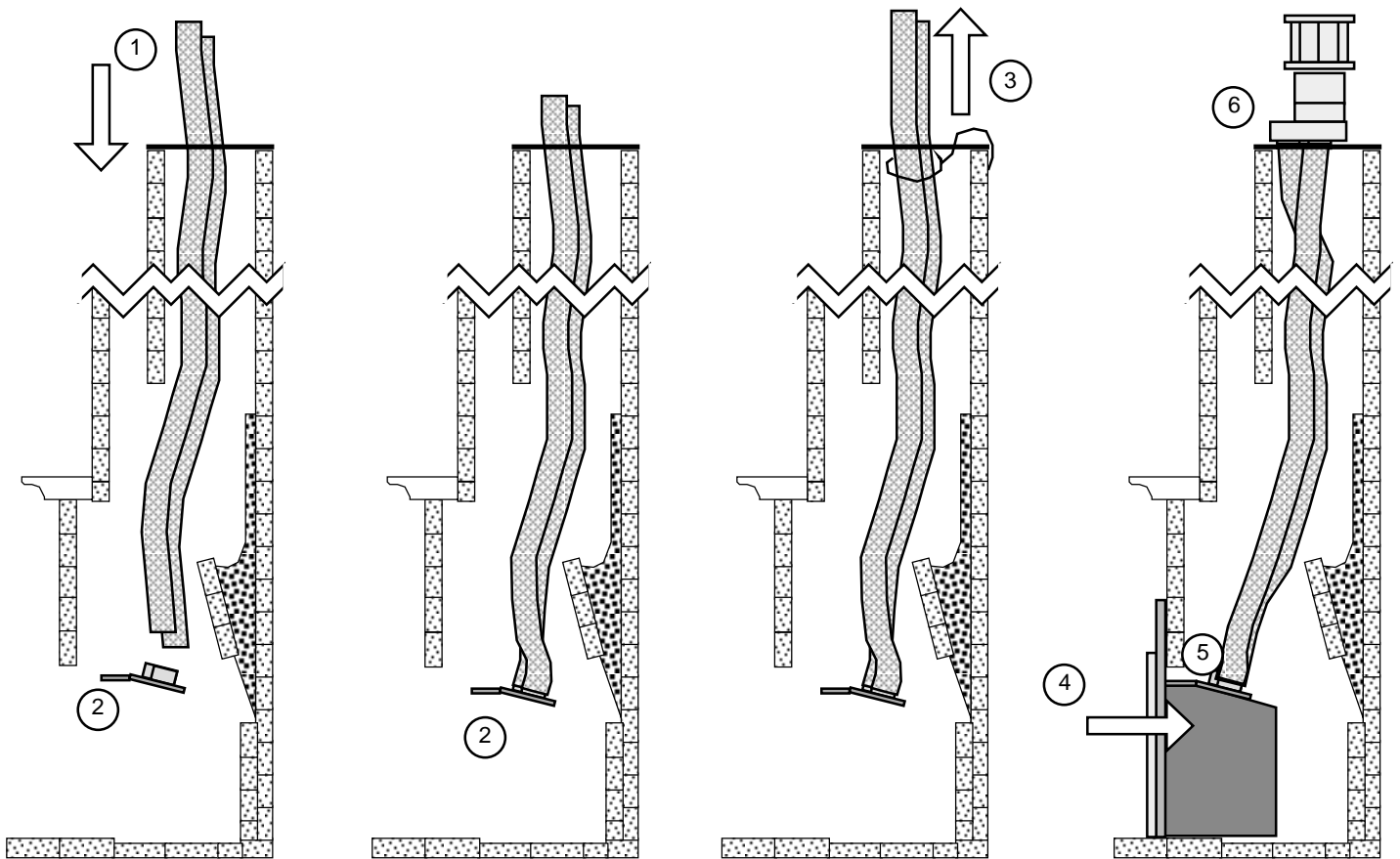

Vent Connector Removal and Installation (continued)

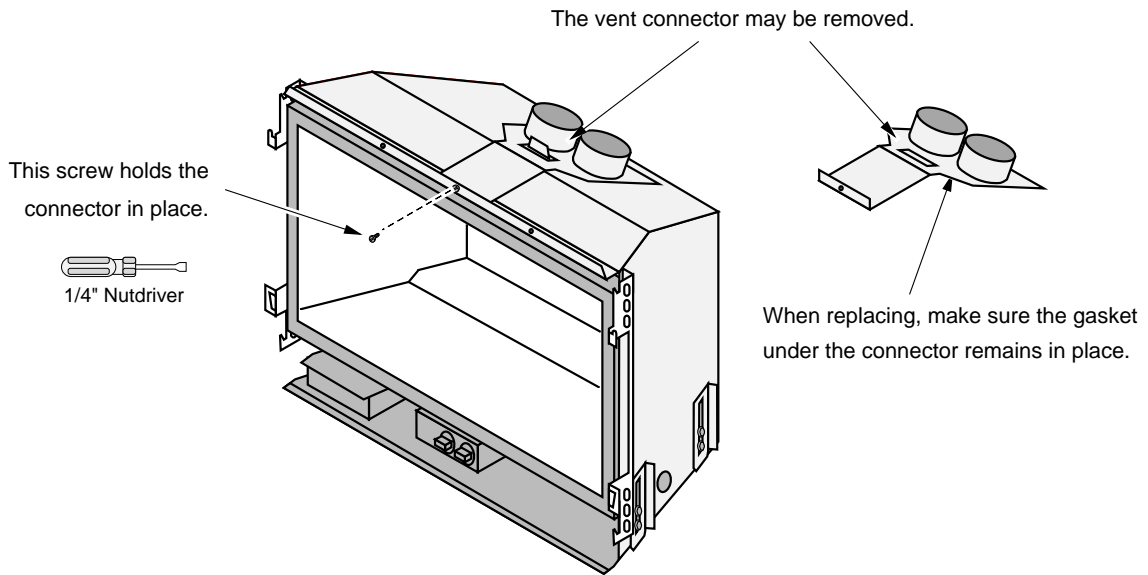

The vent connector slides back and disengages from the three tabs on top of the insert.

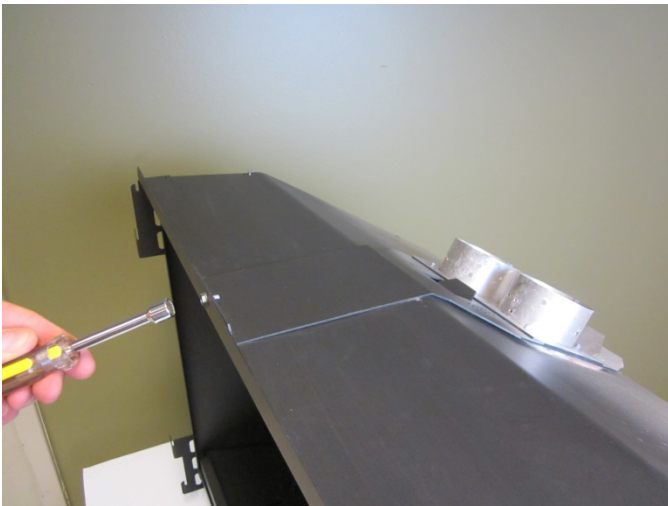

Connect the flex vent (exhaust and intake) to the vent connector (use self-drilling screws or hose clamps).

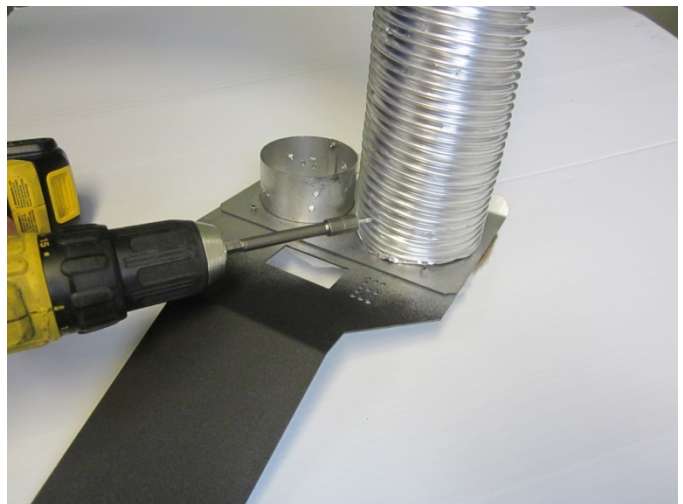
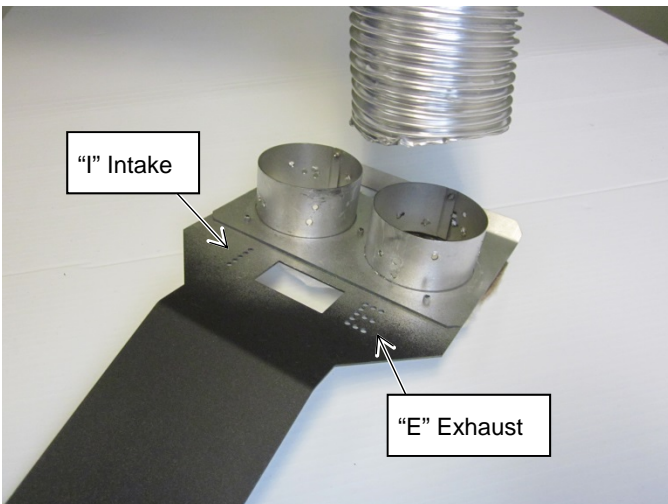

The vent connector, when hanging from the chimney, may be grasped by reaching above the insert. Carefully move the connector forward, making sure all 3 tabs insert through the connector.

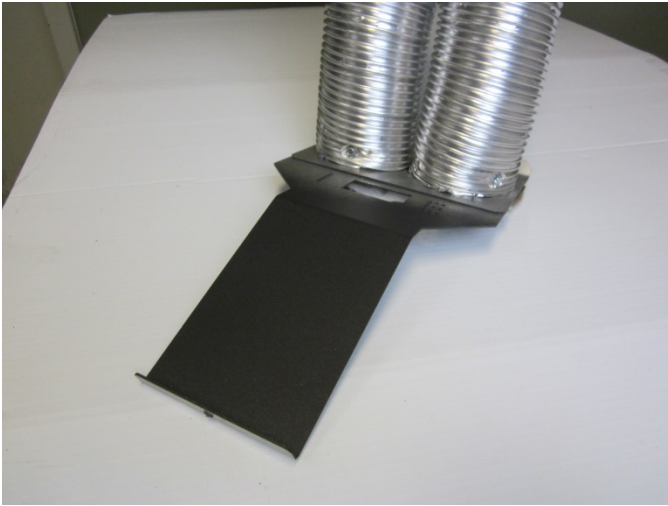

Secure the vent connector to the insert using the screw removed earlier.

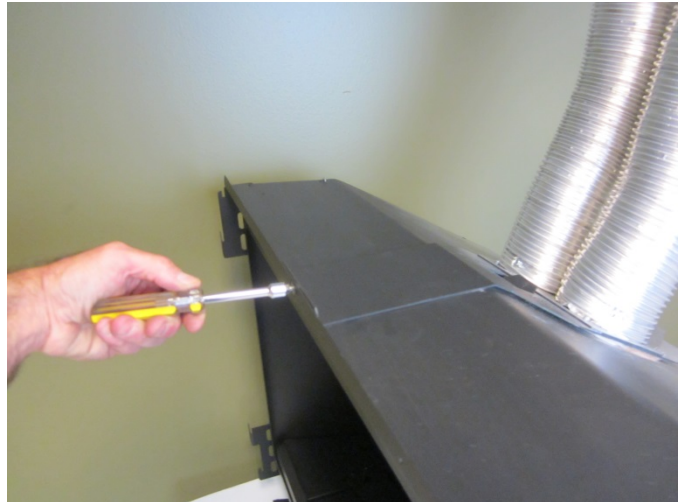
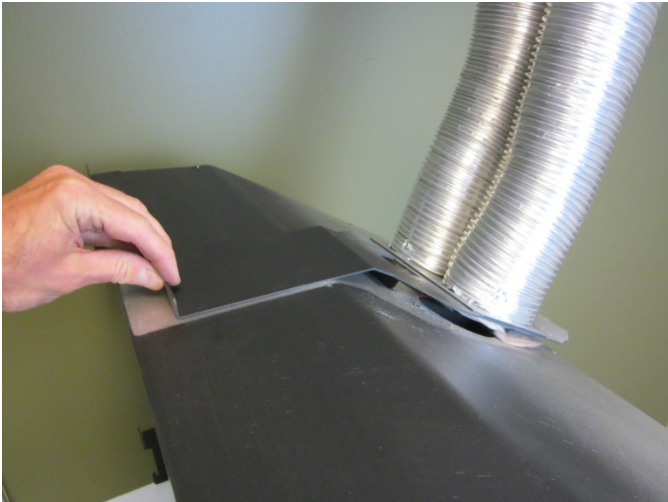

**Surround Panel Installation**

**NOTE:** The insert may be installed without surround panels.

PANEL SIZE	HEIGHT	WIDTH	PART #
Small	30.5"	42"	96100562
Large	34"	44"	96100563

1. The insert should be in position with gas line and flue and intake connections attached, but pulled out slightly to allow panel installation.
2. Attach the surround panel to the insert as shown below.

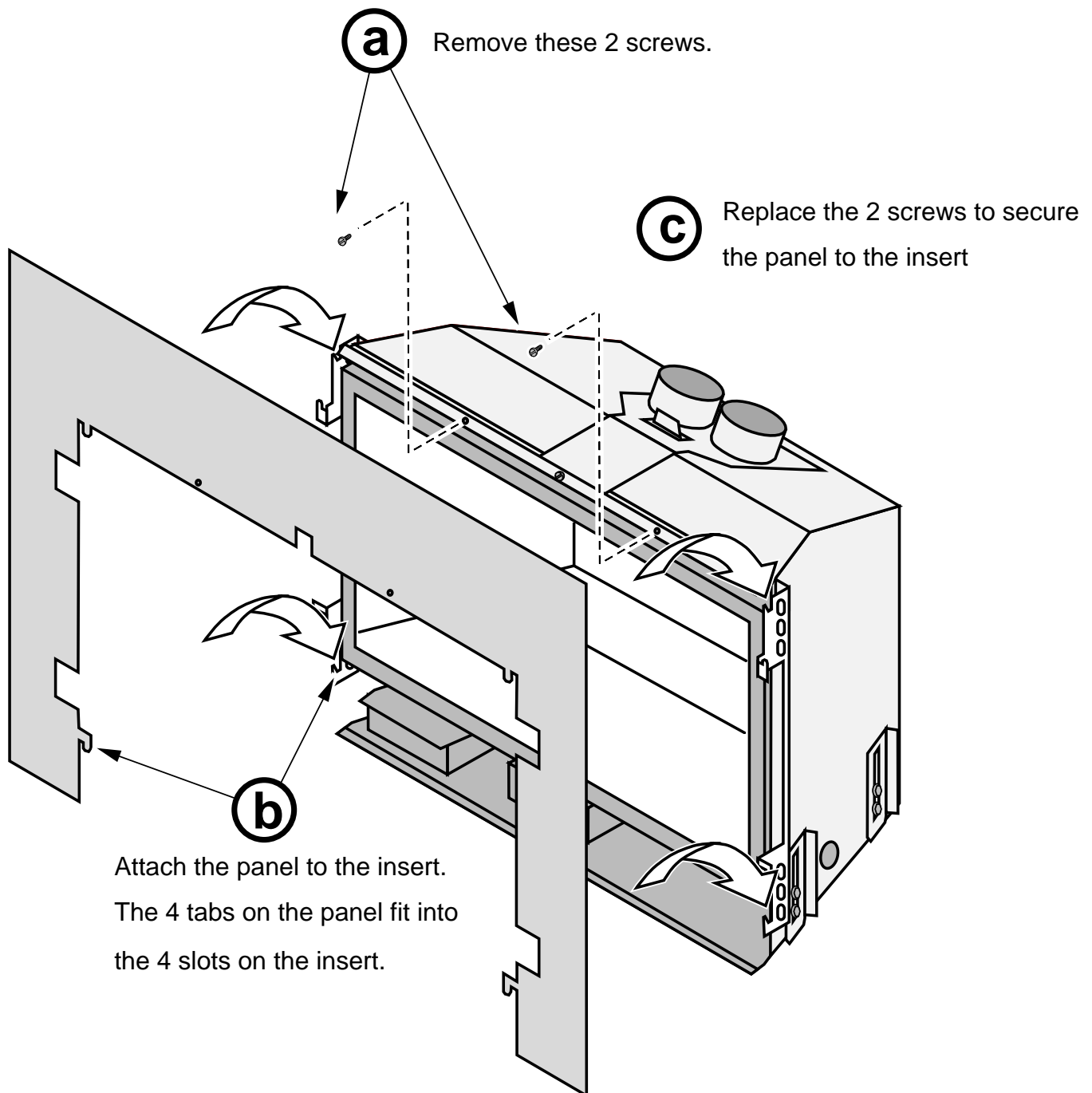

## Glass Frame Removal and Installation



The appliance must be completely cool before removing the glass. Do not strike or slam the glass.

- a** Open the four latches holding the glass frame in place (start with the two below the glass) - follow the directions shown to the right.

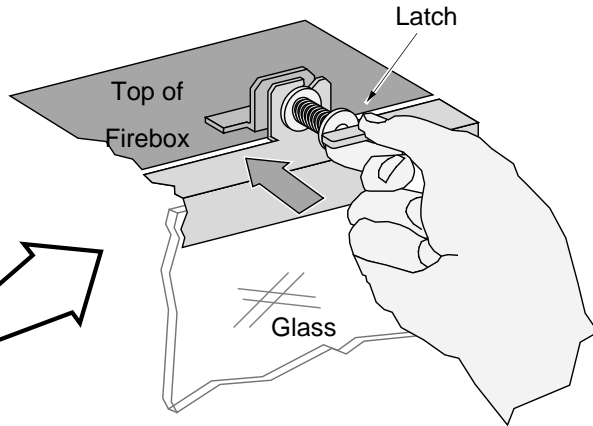
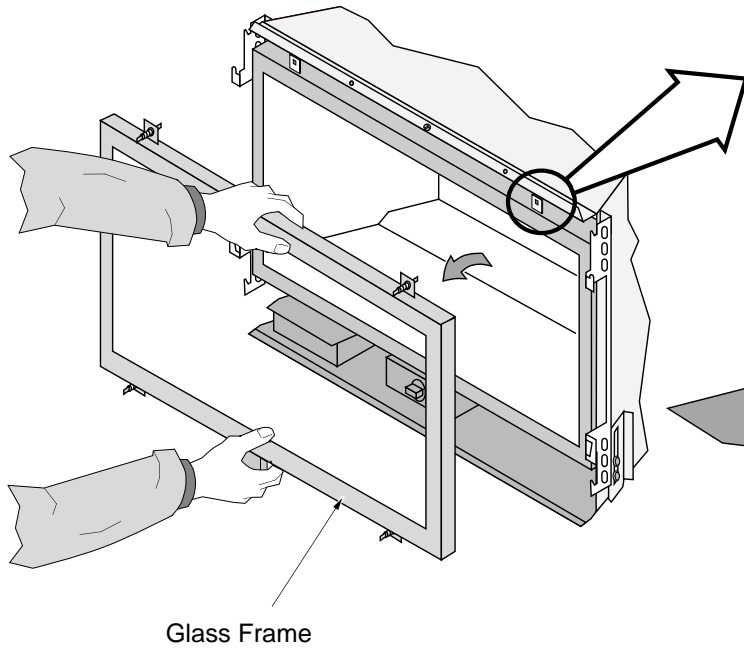

Push in on the latch.

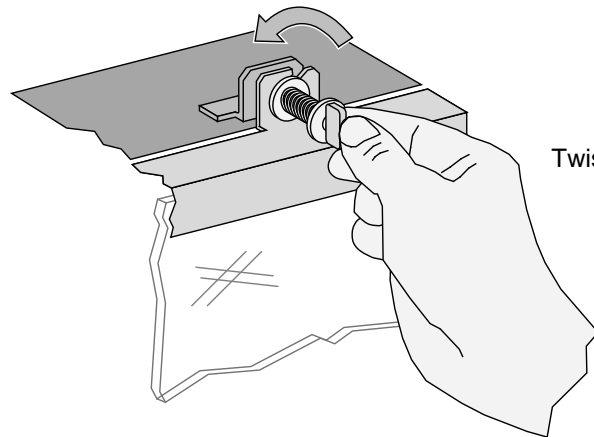

Twist 1/4 turn.

- b** Lift the glass frame up and pull it forward to remove. **NOTE:** You may need to lift the glass frame while re-attaching.

### Re-Attaching the Glass Frame:

- Hang the glass frame on the firebox.
- While holding in place, attach the upper latches (follow the instructions to the right in reverse).
- Lift the glass frame slightly and attach the lower latches.

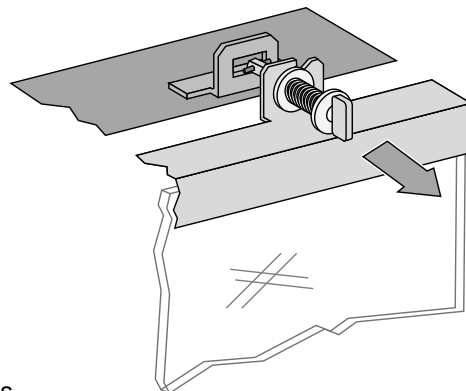

The latch will then disengage from the latch bracket.

***Glass Frame Removal and Installation (continued)***

The glass latch can come loose from the glass frame. This occurs when the latch is turned 1/8 turn when disengaged from the unit. Follow the directions below to re-install the latch if it comes loose.

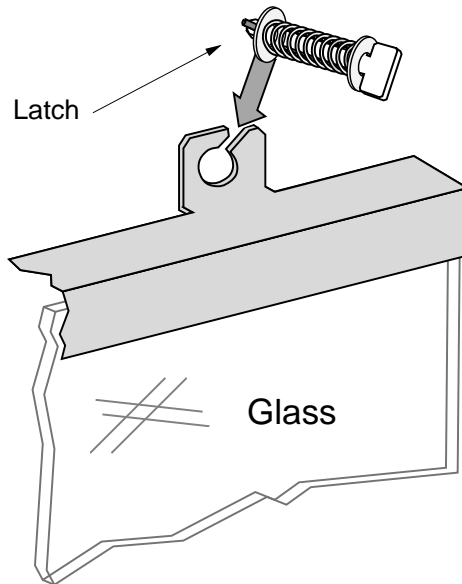

Hold the latch at an angle and insert it into the slot on the glass frame. Note how the washer fits in front of the flange on the glass frame. You will need to push slightly to get the latch to insert.

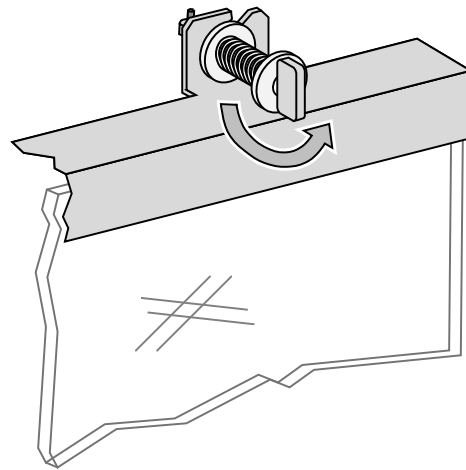

Once fully inserted, turn the latch until it is level.

### Face Installation



A barrier designed to reduce the risk of burns from the hot viewing glass is provided with this appliance and shall be installed for the protection of children and other at-risk individuals.



If the barrier becomes damaged, the barrier shall be replaced with the manufacturer's barrier for this appliance.

The face includes the required barrier screen. Make sure it is in place during operation.

1. The insert should be in position with gas line and flue/intake attached. If using a surround panel, it should be attached as well.
2. Attach the face to the insert as shown below.

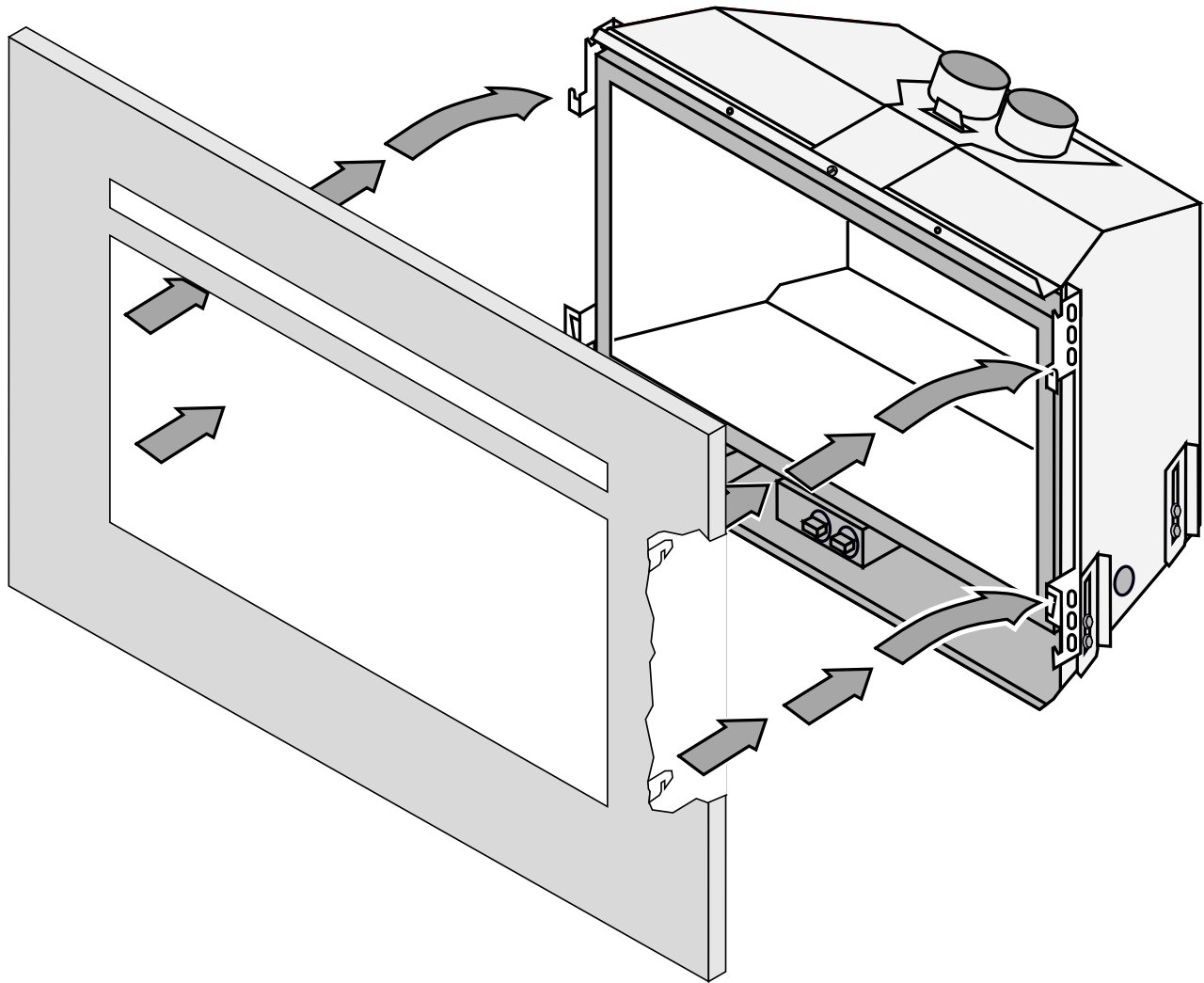

### Log Installation

- ! **The logs are fragile, especially after being exposed to heat.**
- Make sure the gas control valve is "OFF" and the heater is cool prior to conducting service.
  - Failure to position the parts in accordance with diagrams or failure to use only parts specifically approved with this appliance may result in property damage or personal injury.
  - If using propane (LP), convert the appliance before installing the media (see page 43).
  - The burner must be correctly positioned before installing the media. Make sure the burner is fully seated and the pilot is properly aligned. See page 43 for details on burner removal.
  - Install the logs following the directions below.
  - Install the optional firebacks before installing the logs.
- 1 The log stands are shipped on top of the burner. Make sure they are in place with the mounting studs inserted through the holes on the stands.

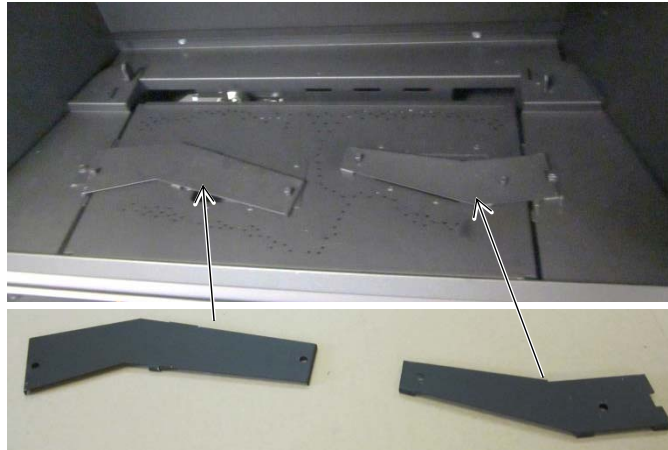

- 2 The rear log has two holes on the bottom. Place it over the two tabs at the back of the firebox.





- 3 The left log has two holes on the bottom. Place the log so the holes fit over the two mounting studs on the left log stand.



- 4 The right log has two holes on the bottom. Place the log so the holes fit over the two mounting studs on the right log stand.

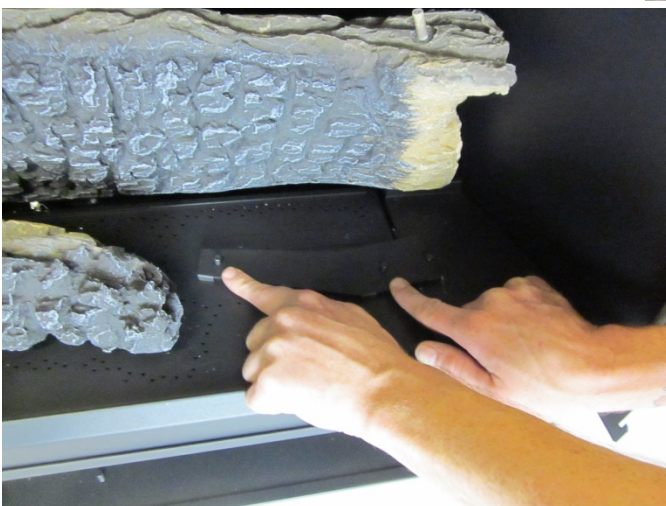

- 5 The left cross log has one hole on the bottom. Place the log so the hole fits over the left pin on the rear log. The front of the log rests on the left log (see picture for orientation).



- 6 The right cross log has one hole on the bottom. Place the log so the hole fits over the right pin on the rear log. The front of the log rests on the right log (see picture for orientation).



- 6 Two twigs are included for the front of the firebox. Place them at the front of the firebox as shown below (**do not place them over any burner holes**).

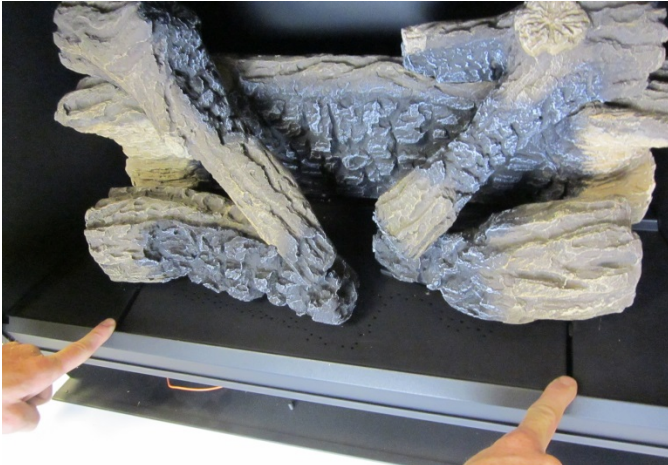

Complete log installation is shown below.



### Rock Wool Placement

The included rock wool is placed on top of the burner to enhance the glow from the burner. **The rock wool works best when it is applied in a very thin, porous layer.** The best method for applying the rock wool is to brush it on to the burner. Compress a clump of rockwool between your thumb and forefinger. Use a stiff brush to apply a thin layer of rockwool fibers onto the burner. Do not use the entire bag of rockwool. Use only a small amount and save the remainder. Over-use of rockwool will diminish the glow and may cause sooting or other adverse conditions.

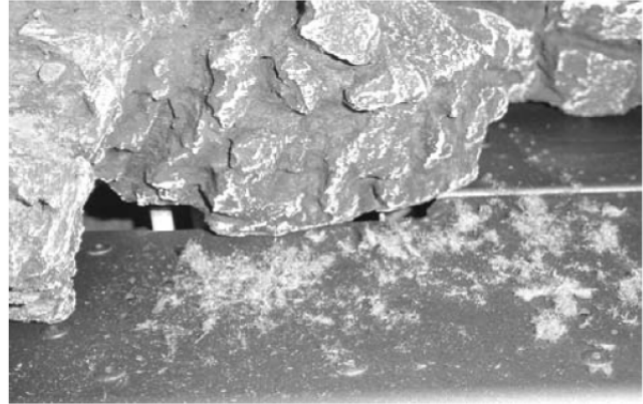

### Ember Placement

Place a layer of embers along the edges of the burner, on top of rivets, and along the edges to enhance the aesthetics of the firebox. Do not place embers over any burner holes. See the photo to the right.



## Steps for Finalizing the Installation

1. Remove the glass (see page 21).

**NOTE:** If using propane (LP) convert the appliance prior to installing the media.

2. We recommend you purge the gas line at this time (with the glass removed). This allows gas to be detected once it enters the firebox, ensuring gas does not build up.
3. Install four AA batteries into the receiver (see page 39 for details). These batteries control on/off operation from the remote and are required for operation.



4. Synchronize the remote to the receiver and put the remote in manual mode.
  - (a) Install batteries into receiver.
  - (b) When red LED light flashes, press any button on the remote.
  - (c) Red light will go out, indicating the remote is synchronized to the receiver.
  - (d) Put the remote in Manual Mode (press both buttons until thermostat icon (thermometer) disappears).



5. Install firebacks (if applicable). Install the log set (page 24).
6. Start the pilot (see instructions on page 32).
7. Replace the glass.
8. Start the main burner and verify the the burner ignites correctly.
9. Leak test all gas joints.

10. Check the air shutter following the directions below.

### Air Shutter Adjustment

Let the heater burn for fifteen minutes (make sure the media and glass are in place). The flames should be yellow with no sooting. Adjust the air shutter, if necessary, to achieve the correct looking flame.

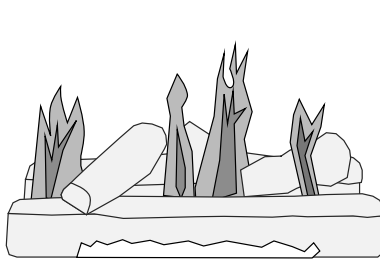

**Correct**

Flames should be blue at the base, yellow-orange on the top.

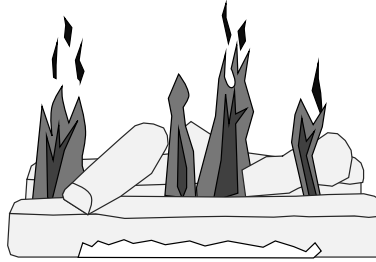

**Not Enough Air**

If the flames are too tall or sooty on the ends, open the air shutter.

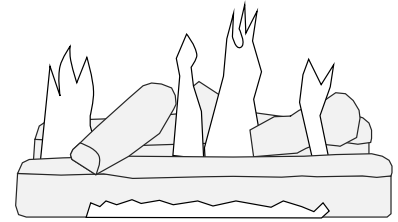

**Too Much Air**

If the flames are all blue and short, close the air shutter.

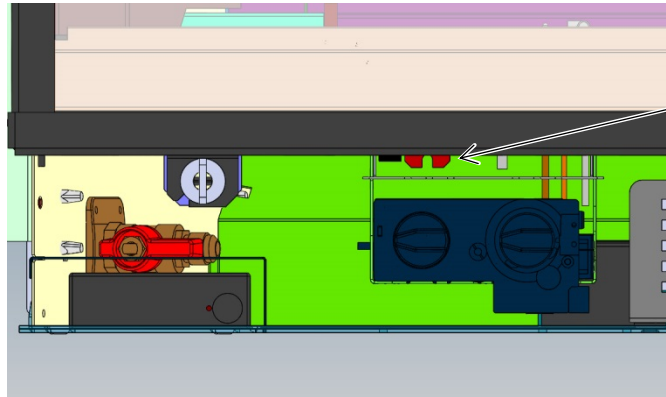

#### **Air Shutter Lever**

(use screwdriver to adjust)

Left = More Air (Open)

Right = Less Air (Closed)

11. Attach the face.
12. Adjust the flame to its highest position - the flames should not contact the top of the firebox. Check the flame on low position. The flames should burn off of each burner hole. If the heater does not work correctly, contact your Travis dealer for a remedy.
13. Give this manual to the home owner for future reference and fully explain operation of this heater.

### ***Before You Begin***

---

- Read this entire manual before you use your new heater (especially the section "Safety Precautions" on pages 4 & 5). Failure to follow the instructions may result in property damage, bodily injury, or even death.



Turn off the main gas supply to the appliance during appliance installation or maintenance.



During appliance installation or maintenance or in case of remote control malfunction turn off the main gas supply.

### ***Location of Controls***

---

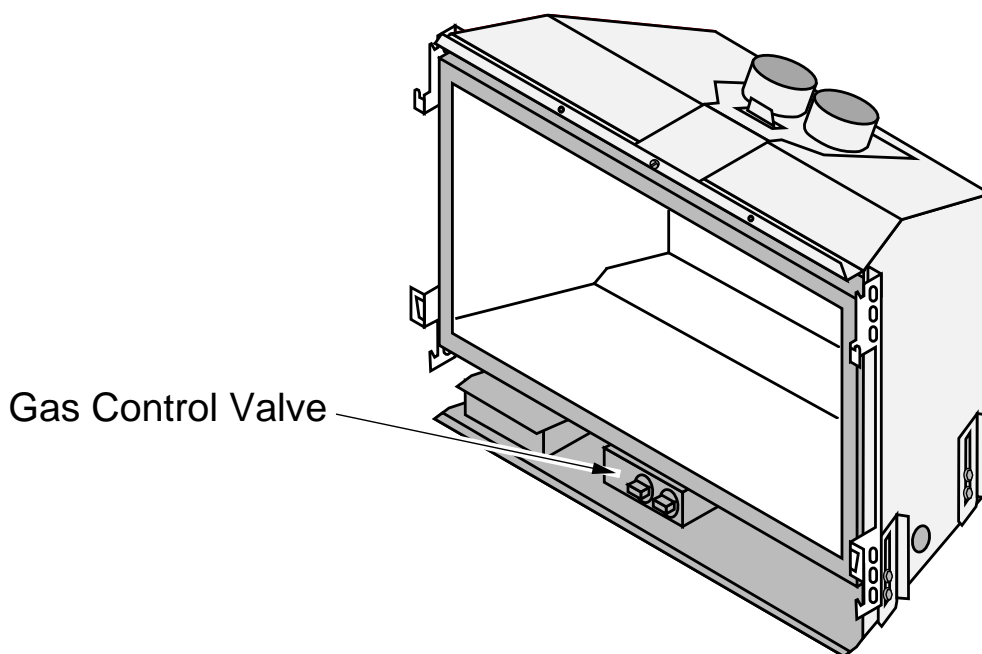

To access the gas control valve, remove the face. The location is shown below.



## Starting the Pilot



Remove the glass frame before starting the pilot.

1. STOP! Read the safety information to the left and below.
2. Turn off all electrical power to the appliance.
3. Set remote to manual mode.
4. Turn flame adjustment knob clockwise  as far as possible to "OFF" position.
5. Push in gas control knob slightly and turn clockwise  to "OFF".

NOTE: knob cannot be turned from "PILOT" to "OFF" unless knob is pushed in slightly. Do not force.

6. Wait five (5) minutes to clear out any gas. Then smell for gas, including near the floor. If you smell gas, STOP! Follow "B" in the safety information to the left on this label. If you don't smell gas, go to the next step.

7. Locate the pilot in the firebox along the top surface of the burner.

8. Turn gas control knob counter-clockwise  to "IGN" position.

9. Push in control knob and turn counter-clockwise  to "PILOT" to spark igniter and light pilot. If pilot does not light return knob to "IGN" and repeat step 9. Once pilot is lit, continue to hold the control knob in for about 30 seconds. Release knob and it will pop back up. Pilot should remain lit. If it goes out, repeat steps 5 through 9.

- If the knob does not pop up when released, stop immediately and call your service technician or gas supplier.
- If the pilot will not stay lit after several tries, turn the gas control knob to "OFF" and call your service technician or gas supplier.

10. Turn gas control knob counter-clockwise  to "ON".

11. Turn on all electrical power to the appliance.

12. To turn on burner, use remote or turn flame adjustment knob counter-clockwise  to desired flame setting.

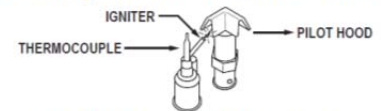
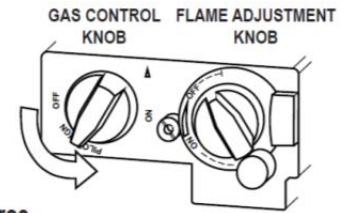

**WARNING:** If you do not follow these instructions exactly, a fire or explosion may result causing property damage, personal injury or loss of life. When lighting or re-lighting the pilot, the glass must be removed. After the pilot is lit replace the glass before lighting the burner.

- A. This appliance has a pilot that must be lighted by hand. When lighting the pilot, follow these instructions exactly.
- B. BEFORE LIGHTING, smell around the appliance area for gas. Be sure to smell next to the floor because some gas is heavier than air and will settle on the floor.

### WHAT TO DO IF YOU SMELL GAS

- Do not try to light any appliance.
  - Do not touch any electric switch; do not use any phone in your building.
  - Immediately call your gas supplier from a neighbor's phone. Follow the gas supplier's instructions.
  - If you cannot reach your gas supplier, call the fire department.
- C. Use only your hand to push in or turn the gas control knob. Never use tools. If the knob will not push in or turn by hand, don't try to repair it, call a qualified service technician. Force or attempted repair may result in a fire or explosion.
  - D. Do not use this appliance if any part has been under water. Immediately call a qualified service technician to inspect the appliance and to replace any part of the control system and any gas control which has been under water.

## Starting the Heater for the First Time

- Burn the heater at a high setting with the blower off for an extended period (up to 48 hours). This will cure the painted surfaces. **Fumes** from the paint curing and oil burning off the steel will occur. This is normal. We recommend opening a window to vent the room.
- **Condensation** may appear on the glass each time you start the heater - this is normal.
- **Blue Flames** will occur on the heater when it first comes on. After fifteen minutes the flames will turn a more realistic yellow and orange color.
- Verify the power backup and control light batteries are installed (see page 39).



## Remote Control Operation

### THERMOSTATIC/TIMER HANDSET FEATURES



Figure 1: R300 Handset

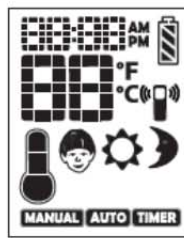

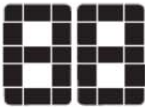









Figure 2: R300 LCD Icons

LCD Icon	Feature and Description
	Timer OFF Icon and Sleep Mode. After 8 hours of no signal between the handset and the receiver, valve runs to pilot and Sleep Mode Icon is displayed. Also indicates Timer OFF Setpoint is active.
	Timer ON Icon: Indicates Timer ON Setpoint is active.
	Main Display: Used to show Ambient Temperature, Setpoints, and Timer 1 and Timer 2.
	Temperature Range Indicator: Indicates handset is operating automatically. The set-point temperature is relative to the current ambient temperature. (See below)
	Child Safety Lock: When ON (icon showing), the right button must be pushed twice within 0.5 seconds to increase flame height.
	Battery Life Indicator: Outline starts blinking with approx. 30 days battery life remaining.
	Clock Display: Set to 12 or 24 hour clock.
	Communication Indicator: Indicates the handset is transmitting to the receiver.
	Manual Mode Icon: Indicates system can be operated manually.
	Thermostatic Mode Icon: Indicates system is operating automatically.
	Timer Icon: Indicates system timers are active.

### TEMPERATURE RANGE INDICATOR

Indicates set point temperature is within this range:



Figure 3: Indicator Bars

- 1 bar: When ambient temperature is > set-point temperature +2°C.
- 2 bars: When ambient temperature is within +/- 2°C of set-point temperature.
- 3 bars: When ambient temperature is < set-point +2°C.

## Remote Control Operation (continued)

### INITIAL SETUP

#### SETTING THE ELECTRONICS CODE

##### Radio Frequency Remote

A code is selected automatically for all Mertik Maxitrol electronics from among 65,000 random codes available.

On initial and subsequent receiver battery changes, the receiver has to learn the code of the handset:

- Power the handset by inserting batteries.
- Insert batteries in receiver. LED on receiver will start to blink.
- While LED on receiver is blinking, press any button on the handset.
- When LED on the receiver stops blinking, the code is set.

**NOTE:** These remote handsets and receivers are not interchangeable with previous versions. For all lighting instructions please refer to appliance manufacturer's instructions.

#### CHANGING THE MODE OF OPERATION

Press and release both buttons  to change the mode of operation (in operating mode) in the following order:

- Manual Mode
- Thermostatic Mode
- Timer Mode

1. Press and release both buttons 

- Manual Operating Mode: Ambient temperature is shown along with battery life indicator, and the current time.



2. Press and release both buttons 

- Thermostatic Operating Mode: Ambient temperature is shown along with battery life indicator, temperature range indicator, and the current time.

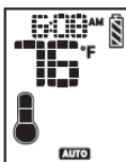

3. Press and release both buttons 

- Timer Mode: Ambient temperature is shown along with battery life indicator, temperature range indicator, the current time, and either Timer ON (sun) or Timer OFF (moon) visible.



OR



### NOTICE

**READ THROUGH THIS ENTIRE NOTICE BEFORE ATTEMPTING INITIAL SETUP / PROGRAMMING.**

A red number/icon indicates the icon is blinking. This will help determine which menu item is being set or programmed.



When programming a menu item, use the right (up) button ONLY. Pressing the left (down) button will cause the programming menu to skip to the next menu item. If you accidentally skip to the next menu item, you must cycle through all the menu items to return to the item you were programming.

Adjusting a menu item, the number will scroll up only (1, 2, 3...) and will cycle back to the beginning number.

15 seconds of inactivity will cause the remote to automatically go to operation mode. Follow Step 1. INITIAL SETUP - PROGRAMMING MODE (below) to return to programming mode. Any changes will be saved each time you exit programming mode.



If the Sun and Moon icons are both flashing, the timers are incorrectly set. The OFF time is overlapping the ON time. The timers must be reset.

### INITIAL SETUP - PROGRAMMING MODE

- Press  (both buttons) and hold for 5 seconds (until screen blinks) to enter Programming Mode.
- Press  (down) to scroll through menu items.
- Press  (up) to adjust menu items.



### SETTING °F OR °C



1. Press  (up) button to choose either °F or °C.
- Press  (down) button to set and scroll to the next menu item.



### SETTING 12 HOUR OR 24 HOUR MODE

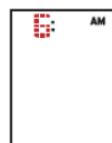

2. Press  (up) button to choose either "12" or "24".
- Press  (down) button to set and scroll to the next menu item.

### SETTING THE HOUR





3. Press  (up) button to set the Hour, 1-12 or 0-23.
- NOTE:** Use right (up) button only. Numbers scroll up (1, 2, 3, ..) to 12 or 23 then cycle back to 1 or 0.
- Press  (down) button to set and scroll to the next menu item.

**Remote Control Operation (continued)**

**INITIAL SETUP - PROGRAMMING MODE CONT.**

**SETTING THE MINUTES**



4. Press  (up) button to set Minutes, 00-59.  
**NOTE:** Use right (up) button only. Numbers scroll up (1, 2, 3...) to 59 then cycle back to 00.
- Press  (down) button to set and scroll to the next menu item.

**SETTING CHILD SAFETY LOCK**





5. Set Child Safety Lock either ON or OFF.  
 • Press  (up) button to set Child Safety Lock ON (icon showing) or OFF.
6. This concludes your basic programming. The remote will automatically save your changes and go into operation mode after 15 seconds of inactivity.
7. Or you can go into Timer Mode Programming.

Press  (down) button to set and scroll to the next menu item. This will enter you into Timer Mode Programming.

**FLAME HEIGHT ADJUSTMENT**



**MANUAL MODE:**

**(Manually Adjusting Flame Height)**

- To turn the main burner ON or to increase the flame height, press the  (up) button.
- To decrease the flame height, press the  (down) button or turn main burner OFF.



**THERMOSTATIC MODE:**

Flame height adjusts automatically to achieve set temperature.

- Press the  (up) button to increase or the  (down) button to decrease setpoint by 1°F/C. \*  
 \* When entering Thermostatic mode, the current ambient temperature is the initial setpoint temperature.

**TIMER MODE:**

Each can be programmed for a single Timer ON temperature and a single Timer OFF temperature. Timer 1 and Timer 2 can be programmed to go ON and OFF at specific times.



- Press the  (up) button to increase or the  (down) button to decrease setpoint by 1°F/C. \*  
 \* Manually adjusting the temperature in Timer Mode changes the setpoint temperature of Timer 1 or Timer 2.

**TIMER PROGRAMMING MODE**

**NOTE:** Use  (up) button only to adjust menu items. Numbers scroll up to the highest setting and then cycle back to the beginning number. Temperature setting cycle back to OFF or pilot ("--").



**SETTING "ON" TEMPERATURE**



1. Press  (up) button to set ON temperature for BOTH Timer 1 and 2 (Sun icon visible).
- Press  (down) button to set and scroll to the next menu item.



**SETTING "OFF" TEMPERATURE**



2. Press  (up) button to set OFF temperature for BOTH Timer 1 and 2 (Moon icon visible).  
**NOTE:** OFF temperature can not be set higher than your ON temperature.
- Press  (down) button to set and scroll to the next menu item.



**SETTING TIMER 1 "ON" TIME**



3. Set Timer 1 ON time.  
 • Press  (up) button to set ON time (scrolls in 15 minute increments).
- Press  (down) button to set and scroll to the next menu item.

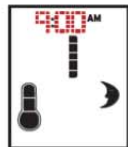

**SETTING TIMER 1 "OFF" TIME**



4. Set Timer 1 OFF time.  
 • Press  (up) button to set OFF time (scrolls in 15 minute increments).
- Press  (down) button to set and scroll to the next menu item.



**SETTING TIMER 2 "ON" TIME**



5. Set Timer 2 ON time.  
 • Press  (up) button to set ON time (scrolls in 15 minute increments).
- Press  (down) button to set and scroll to the next menu item.

**SETTING TIMER 2 "OFF" TIME**



6. Press  (up) button to set OFF time (in 15 minute increments).
- Press  (down) button to set and scroll to the next menu item.



7. This concludes programming Timers 1 and 2. The remote will automatically save your changes and go into operation mode after 15 seconds of inactivity.

## Remote Control Operation (continued)

### SLEEP MODE





After 8 hours of no signal between the handset and receiver, valve runs to pilot and  Sleep Mode Icon is displayed.

### TURN OFF GAS TO APPLIANCE

- Access the gas control.
- Turn the main valve knob clockwise  to the PILOT position. Push in knob; turn and release. Continue turning to the OFF full clockwise  position.
- Replace appliance accessibility cover (if applicable),

### MANUAL VALVE OPERATION

Access to the pilot burner is only required for ignition with a match.

1. **STOP!** Read the safety information included before proceeding.
2. Turn MAIN valve knob to the OFF, full clockwise  position.
3. Turn MANUAL knob to the full clockwise  position.
4. Wait five (5) minutes to clear out any gas. Verify that no gas is in the area around the appliance, including near the floor. **If you detect gas STOP! Follow Warnings (see pg. 1) under "WHAT TO DO IF YOU SMELL GAS".** If no gas is present, proceed to step 5.
5. Turn MAIN valve knob slightly counterclockwise  towards the IGN position until it stops, then press down and continue turning counterclockwise  to the PILOT position. Continue to hold down knob for 10 seconds after pilot burner has been lit. If pilot does not light, steps 1 and 2 may be repeated.

**NOTE:** If the pilot does not stay lit after several tries, turn MAIN valve knob to the PILOT position. Push in knob; turn and release. Continue turning to the OFF full clockwise  position and proceed to step 7.

6. Upon lighting, release knob and turn MAIN valve knob fully counterclockwise  to ON position.
7. If the appliance will not operate, follow the instructions "Turn Off Gas to Appliance" (above).

### MANUAL FLAME HEIGHT OPERATION

The motorized valve is equipped with a slip clutch allowing manual adjustment of the main burner by turning the MANUAL knob. When turning the MANUAL knob, do not apply excessive force.

### STANDBY PROCEDURE

Turn main valve knob clockwise  to PILOT position, allowing only pilot gas to flow.



Figure 4: Wiring Diagram for OEM use only.

### ⚠ WARNING

To keep receiver free from debris and dirt, do not remove the receiver from the plastic bag until all construction is complete.

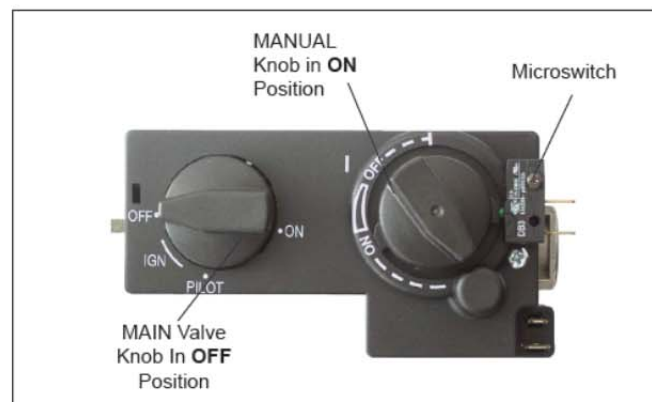

Figure 5: Combination Control

## Normal Operating Sounds

### Extinction Pops

It is not unusual, especially on Propane (LP) appliances, to experience a "pop" when the burner is shut off.

### Pilot Assembly

The pilot flame will make a slight whisper sound.

### Gas Control Valve

As the gas control valve is turned on and off and the flame height changed you will hear the flame height motor.

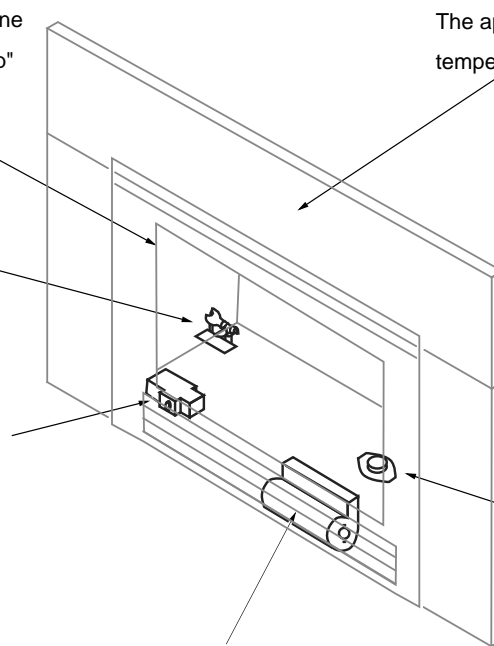

The appliance may creak with change of temperature -- THIS IS NORMAL.

### Optional Blower Snap Disk

This part can produce a clicking sound as it turns the blower on and off.

### Optional Blower

This heater has an optional blower to push heated air into the room. You will hear the sound of air movement that increases as the speed is increased.

## Normal Operating Odors

This appliance has several areas that reach high temperatures. Dust or other particles on these areas may burn and create an odor. This is normal during start-up. You may notice the smell is more acute if the appliance was left idle for a long period.

## Power Outages

The heater will work if household current (AC power) is disconnected.

**DANGER HIGH VOLTAGE:** Disconnect power before attempting maintenance or repair.

**Battery Replacement**

Four AA batteries are used to power the receiver and two AAA batteries are used to power the remote control. These batteries are required for operation. Replace batteries before each heating season to ensure proper operation.

- Remove the heat shield above the receiver (it is held in place with hook-and-loop tape and a tab on the left side).

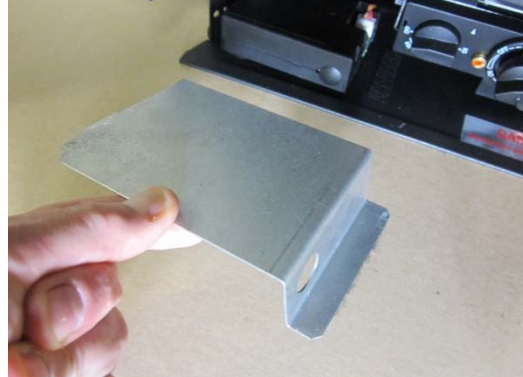
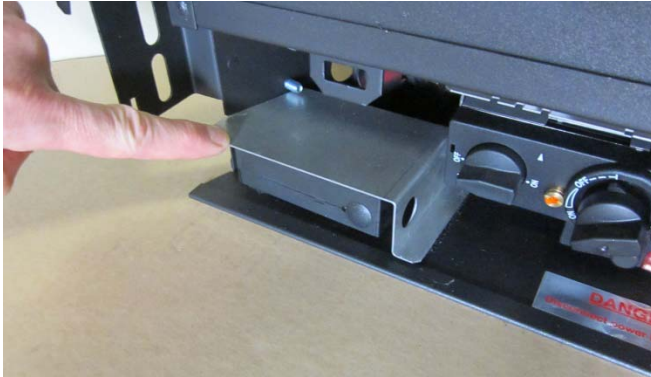

- Remove the receiver from the insert and place it in front of the insert (it is held in place with hook-and-loop tape). Remove the battery cover on top of the receiver and install four new AA batteries into the receiver.

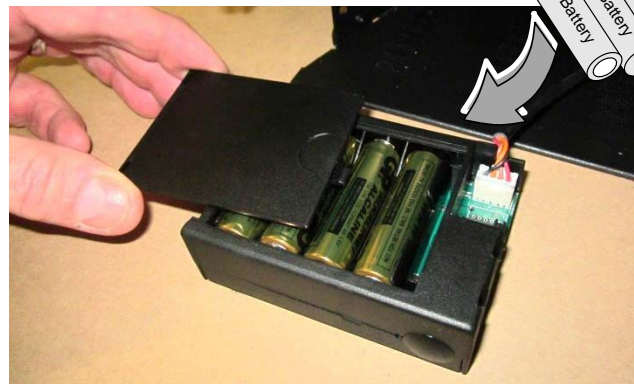
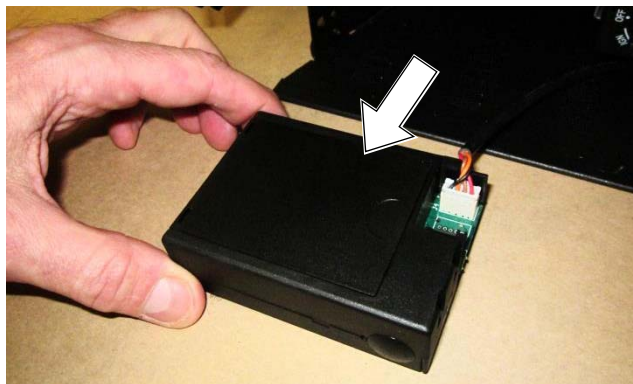

- Replace the cover on the receiver and place it back into position. Replace the heat shield (note how the tab on the left side of the heat shield inserts into a slot on the side of the insert).



- Install two AAA batteries into the remote control.



## Maintaining Your Heater's Appearance



**The appliance must be completely cool prior to conducting service.**

### Cleaning The Glass

The glass may be cleaned with a non-abrasive cleaner. To clean the inside of the glass, simply remove the glass frame, place it on a non-scratching surface, and clean the surface.

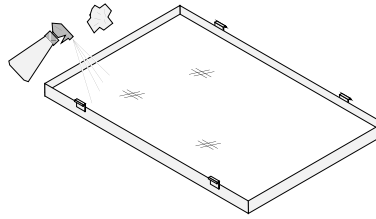

### Cleaning the Face and Panels

Use a duster to remove dust from the face and panels. Contact your dealer if you wish to re-paint any surfaces. Heat-resistant stove-paint (with instructions) is available from your dealer.

## Yearly Service Procedure

- Failure to inspect and maintain the heater may lead to improper combustion and a potentially dangerous situation. We recommend the following procedures be done by a qualified technician.
1. Turn the pilot flame to continuous. It should touch approximately 3/8" of the top of the flame sensor. If it does not, contact your dealer for service.
  2. Shut off gas to the heater and let it cool for 15 minutes. Remove the glass (see page 21). Glass may be cleaned with glass cleaner and a soft cloth (do not use abrasive cleaners).
  3. Remove the media (see the instructions included with your media kit). If severely deteriorated, replace. Check the media for sooting. A small amount of soot along the bottom of the media is normal. If excessive sooting is found, the heater will require adjustment. Contact your dealer.
  4. Inspect the burner and remove any debris.
    - Make sure the burner is not warped, cracked, or damaged.
    - Check the firebox and area around the pilot to make sure there is no warping or damage.
    - If any problem is found, discontinue use and contact your dealer for service.
  5. Replace the media. Clean and replace the glass. If the glass is damaged, replace. Make sure the gasket along the perimeter of the glass contacts the face of the firebox and forms an air-tight seal. If it does not, re-align or replace the gasket to insure an air-tight seal.
  6. Inspect the area behind the access door. Clean if necessary. Check the gas control valve and the gas lines. If damage is found, discontinue use and contact your dealer for service. Clean the air channels, ducts, and blower (if applicable).
  7. Start the main burner. Inspect the main burner and pilot flame. After 15 minutes the flames should be orange/yellow and not touch the top of the firebox. If the pilot or main burners do not burn correctly, contact your dealer for service. Monitor blower operation.
  8. Remove any debris or vegetation near the vent termination. Contact your dealer if any sooting or deterioration is found near the vent termination. Venting system should be examined by a qualified agency.

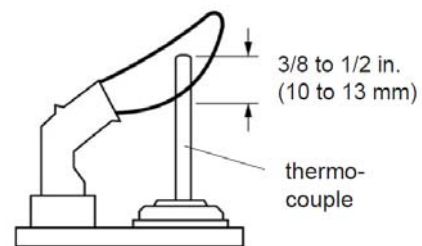

### Replacement Parts List

---

**Caution:** Use only Travis Industries replacement parts. Do not use substitute materials.

**Warning:** Do not operate appliance with the glass front removed, cracked, or broken. Replacement of the glass should be done by a licensed or qualified service person.

Contact your local Travis Industries Dealer for a Replacement Parts List

### Wiring Diagram

---

**Caution:** Label all wires prior to disconnection when servicing controls. Wiring errors can cause improper and dangerous operation.

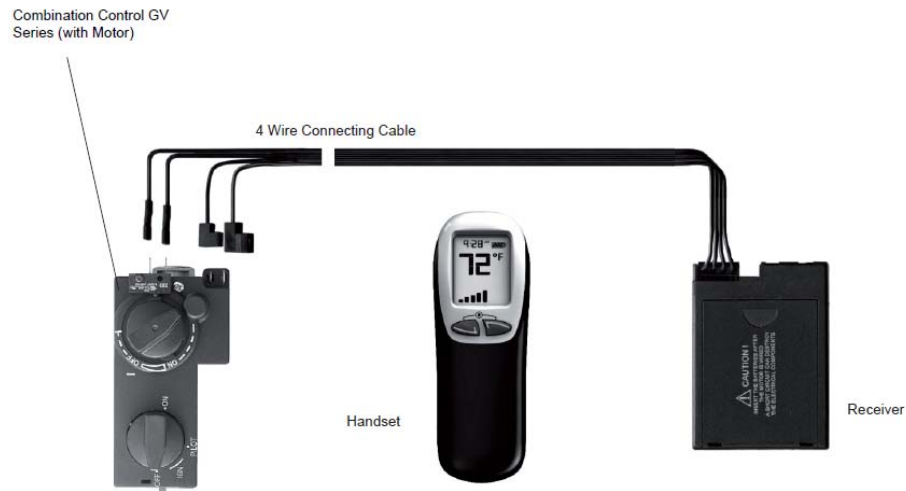



## Safety Label

The safety (listing) label is attached to the operating tag (chained to the heater near the gas control valve). A copy is shown below

Enclosure minimum height		Minimum Clearances to Combustibles	
Enclosure minimum width	23.75" (604mm)	Base of Insert to Mantel	See Owner's Manual
Enclosure minimum depth	31.5" (801mm)	Base of Insert to Top Facing	See Owner's Manual
	14.875" (378mm)	Minimum chimney flue size	7" (178mm)

FAN TYPE VENTED CIRCULATOR (OPTIONAL)	
Blower Electrical Rating: 120V, 0.55 Amps, 60 Hz, 37 Watts (Part No. 99000192 fan or blower assembly may be used)	
For use only with barrier Part No. 250-03379 (Universal and Times Square Faces) or 250-03804 (Rosario Face). Follow installation instructions	

  

Input Rate on "HI" (BTU/Hr)	L.P.	N.G.	Minimum Inlet Pressure (inches W.C.)	L.P.	N.G.
30,000	30,000	33,000	11"	11"	5.5"
15,000	15,000	17,000	13"	13"	7"
#52	#52	#35	10.2"	10.2"	3.5"

This appliance is equipped for use only at altitudes 0-2,000 feet (0-610m) in the USA. In Canada, 0-4,500 feet (0-1370m). For altitudes above 2,000 feet, the vent configuration, orifice, or combination of both may need to be changed. See owner's manual for information on making these changes.

MANUFACTURE DATE:		Manufactured by:	
<input type="checkbox"/> 2015	<input type="checkbox"/> Jan.	<input type="checkbox"/> Apr.	 <b>TRAVIS INDUSTRIES</b> HOME OF FIRE 12524 Harbor Reach Drive Mukilteo, WA 98275 www.travisproducts.com
<input type="checkbox"/> 2016	<input type="checkbox"/> Feb.	<input type="checkbox"/> May	
<input type="checkbox"/> 2017	<input type="checkbox"/> Mar.	<input type="checkbox"/> Jun.	
<input type="checkbox"/>	<input type="checkbox"/>	<input type="checkbox"/> Sep.	
<input type="checkbox"/>	<input type="checkbox"/>	<input type="checkbox"/> Oct.	
<input type="checkbox"/>	<input type="checkbox"/>	<input type="checkbox"/> Nov.	

**WARNING:** This fireplace has been converted for use with a gas fireplace insert only and cannot be used for burning wood or solid fuels unless all original parts have been replaced, and the fireplace re-approved by the authority having jurisdiction.

**WARNING:** Failure to install this appliance per the manufacturer's instructions or failure to use only parts specifically approved with this appliance may result in property damage or personal injury.

**VENTED GAS FIREPLACE HEATER - NOT FOR USE WITH SOLID FUEL**

**CAUTION:** Do not operate this appliance with glass removed, cracked or broken. Replacement of the panel(s) should be done by a licensed or qualified service person.

1190

**Radiant Plus Large Insert**  
 Vented Gas Fireplace Heater

Listed by  Underwriters Laboratories, Inc.  
 Report No. 00261015  
 Certified for USA and Canada

Tested to: ANSI Z21.88-2014/CSA 2.23-2014, "Vented Gas Fireplace Heater"; CGA 2.17-M91 (R2009), "Gas-fired appliances for use at high altitudes"; and CSA P-4.1-2009 (R2014) testing method for measuring annual fireplace efficiency.

This appliance must be installed in accordance with local codes, if any; if none, follow the National Fuel Gas Code, ANSI Z223.1/NFPA 54, or Natural Gas and Propane Installation Codes, CSA B149.1.

This appliance must be installed in accordance with the current Standard CAN/CSA Z240.MH, Mobile Housing, in Canada or with the Manufactured Home Construction and Safety Standard, Title 24 CFR, Part 3280, in the United States, or when such a standard is not applicable, ANSINCSBCS A225.1/NFPA 501A, Manufactured Home Installation Standard.

This vented gas fireplace heater is equipped at the factory for use with natural gas. If conversion to propane (LP) is desired, the optional factory conversion kit must be used. Part No. 250-03736 kit may be used.

This appliance is only for use with the type(s) of gas indicated on the rating plate and may be installed in an aftermarket, permanently located, manufactured home (USA only) or mobile home, where not prohibited by local codes. See owner's manual for details. This appliance is not convertible for use with other gases, unless a certified kit is used.

This vented gas fireplace heater is not for use with air fillers.

Keep burner and control compartment clean. See installation and operating instructions accompanying appliance.

This appliance must be properly connected to a venting system in accordance with the manufacturer's installation instructions. Use only an approved direct vent system to vent this appliance to the exterior. See owner's manual for approved brands of venting.

If the vent-air intake system is disconnected for servicing or any other reason, it must be resealed and / or reinstalled.

**WARNING:** Improper installation, adjustment, alteration, service or maintenance can cause injury or property damage. Refer to the owner's information manual provided with this appliance. For assistance or additional information consult a qualified installer, service agency or the gas supplier.

Register your TRAVIS INDUSTRIES, INC. Limited 7 Year Warranty online at [traviswarranty.com](http://traviswarranty.com), or complete the enclosed Warranty card and mail it within **ten (10)** days of the appliance purchase date to: TRAVIS INDUSTRIES, INC., 12521 Harbour Reach Drive, Mukilteo, WA 98275. TRAVIS INDUSTRIES, INC. warrants this gas appliance (appliance is defined as the equipment manufactured by Travis Industries, Inc.) to be defect-free in material and workmanship to the original purchaser from the date of purchase as follows:

**Check with your dealer in advance for any costs to you when arranging a warranty call.  
Mileage or service charges are not covered by this warranty. This charge can vary from store to store.**

<u>Component</u>	Years 1 & 2 Parts & Labor	Years 3 Through 5 Parts & Labor	Years 6 & 7 Parts Only
<u>Burner Assembly</u> Burner Pan Assembly, Air Shutter Assembly, Main Burner Orifice	✓		
<u>Electrical Assembly (within heater structure):</u> Wiring harness, snap discs, rheostat speed control, blowers, etc.	✓		
<u>Gas Control Assembly</u> Adjustable control valve, fireplace controller, pilot assembly and pilot wiring	✓		
<u>Glass</u> Glass (breakage from thermal shock)	✓		
<u>Media</u> Log Set, Embers, Stones, Crushed Glass	✓		
<u>Gold, Nickel &amp; Copper Plating</u> Face & Door (see "Conditions and Exclusions" # 9)	✓		
<u>Accessories</u> Firebacks, Power Heat Ducts, Andirons, etc...	✓		
<u>One-Way Freight Allowance</u> One-way freight allowance on pre-authorized repair done at factory is covered.	✓	✓	
<u>Convection Heat Exchanger</u> Convection heat exchanger assembly	✓	✓	
<u>Firebox Assembly</u> Adjustable Air Restrictor, Pressure Relief Mechanisms, Glass Attachment Mechanism	✓	✓	✓

### EXCLUDED COMPONENTS:

Paint, Gasketing, and Accent Light Bulbs

### **CONDITIONS & EXCLUSIONS**

- This new gas appliance must be installed by a qualified gas appliance technician. It must be installed, operated, and maintained at all times in accordance with the instructions in the Owner's Manual. Any alteration, willful abuse, accident, neglect, or misuse of the product shall nullify this warranty.
- This warranty is nontransferable, and is made to the ORIGINAL purchaser, provided that the purchase was made through an authorized TRAVIS dealer.
- Discoloration and some minor expansion, contraction, or movement of certain parts and resulting noise, is normal and not a defect and, therefore, not covered under warranty. The installer must ensure the appliance is burning as per the rating tag at the time of installation. Over-firing (operation above the listed BTU rate) of this appliance can cause serious damage and will nullify this warranty.
- The warranty, as outlined within this document, does not apply to the chimney components or other Non-Travis accessories used in conjunction with the installation of this product. If in doubt as to the extent of this warranty, contact your authorized TRAVIS retailer before installation.
- Travis Industries will not be responsible for inadequate performance caused by environmental conditions such as nearby trees, buildings, roof tops, wind, hills or mountains or negative pressure or other influences from mechanical systems such as furnaces, fans, clothes dryers, etc.
- This Warranty is void if:
  - The unit has been operated in atmospheres contaminated by chlorine, fluorine or other damaging chemicals.
  - The unit is subject to submersion in water or prolonged periods of dampness or condensation.
  - Any damage to the unit, combustion chamber, heat exchanger or other components due to water, or weather damage which is the result of, but not limited to, improper chimney/venting installation.
- Exclusions to this 7 Year Warranty include: injury, loss of use, damage, failure to function due to accident, negligence, misuse, improper installation, alteration or adjustment of the manufacturer's settings of components, lack of proper and regular maintenance, damage incurred while the appliance is in transit, alteration, or act of God.
- This 7 Year warranty excludes damage caused by normal wear and tear, such as paint discoloration or chipping, worn or torn gasketing, corroded or cracked logs, embers, etc. Also excluded is damage to the unit caused by abuse, improper installation, modification of the unit, drilling of the orifices, or the use of fuel other than that for which the unit is configured. Units are shipped for natural gas and must be converted to propane using the included conversion kit. Confirm fuel configuration with your installer.
- Damage to gold or nickel surfaces caused by fingerprints, scratches, melted items-, or other external sources left on the gold or nickel from the use of cleaners other than denatured alcohol is not covered in this warranty.
- TRAVIS INDUSTRIES, INC. is free of liability for any damages caused by the appliance, as well as inconvenience expenses and materials. Incidental or consequential damages are not covered by this warranty. In some states, the exclusion of incidental or consequential damage may not apply.
- This warranty does not cover any loss or damage incurred by the use or removal of any component or apparatus to or from the gas appliance without the express written permission of TRAVIS INDUSTRIES, INC. and bearing a TRAVIS INDUSTRIES, INC. label of approval.
- Any statement or representation of TRAVIS products and their performance contained in TRAVIS advertising, packaging literature, or printed material is not part of this 7 year warranty.
- This warranty is automatically voided if the appliance's serial number has been removed or altered in any way. If the appliance is used for commercial purposes, it is excluded from this warranty.
- No dealer, distributor, or similar person has the authority to represent or warrant TRAVIS products beyond the terms contained within this warranty. TRAVIS INDUSTRIES, INC. assumes no liability for such warranties or representations.
- Travis Industries will not cover the cost of the removal or re-installation of hearths, facing, mantels, venting or other components.
- If for any reason any section of this warranty is declared invalid, the balance of the warranty remains in effect and all other clauses shall remain in effect.
- THIS 7 YEAR WARRANTY IS THE ONLY WARRANTY SUPPLIED BY TRAVIS INDUSTRIES, INC., THE MANUFACTURER OF THE APPLIANCE. ALL OTHER WARRANTIES, WHETHER EXPRESS OR IMPLIED, ARE HEREBY EXPRESSLY DISCLAIMED AND PURCHASER'S RECOURSE IS EXPRESSLY LIMITED TO THE WARRANTIES SET FORTH HEREIN.**

### **IF WARRANTY SERVICE IS NEEDED:**

- If you discover a problem that you believe is covered by this warranty, you **MUST REPORT** it to your TRAVIS dealer **WITHIN 30 DAYS**, giving them proof of purchase, the purchase date, and the model name and serial number.
- Travis Industries has the option of either repairing or replacing the defective component.
- If your dealer is unable to repair your appliance's defect, he may process a warranty claim through TRAVIS INDUSTRIES, INC., including the name of the dealership where you purchased the appliance, a copy of your receipt showing the date of the appliance's purchase, and the serial number on your appliance. At that time, you may be asked to ship your appliance, freight charges prepaid, to TRAVIS INDUSTRIES, INC. TRAVIS INDUSTRIES, INC., at its option, will repair or replace, free of charge, your TRAVIS appliance if it is found to be defective in material or workmanship within the time frame stated within this 7 year warranty. TRAVIS INDUSTRIES, INC. will return your appliance, freight charges (years 1 to 5) prepaid by TRAVIS INDUSTRIES, INC., to your regional distributor, or dealership.
- Check with your dealer in advance for any costs to you when arranging a warranty call. Mileage or service charges are not covered by this warranty. This charge can vary from store to store.

## LP (Propane) Conversion Instructions

**Convert the appliance prior to installing the gas line to ensure proper gas use.**

1. Remove the glass frame. Remove the logs (if installed).
2. Remove the two log stands.



3. Remove the 2 screws holding the burner in place.

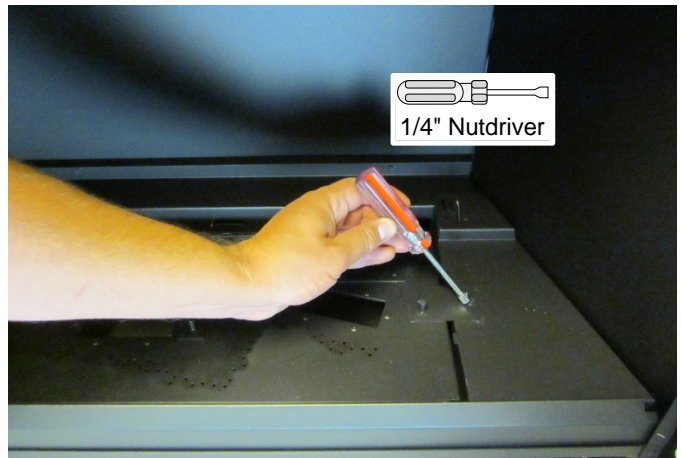

4. Remove the burner and place it aside.



# 44

# Optional Equipment (for qualified installers only)

5. Install the LP (propane) pilot orifice following the instructions below.

(a) Use a 7/16" open-end wrench to remove the pilot hood.

(b) Remove and discard the Natural Gas (NG) orifice. Place the LP orifice in the pilot assembly then replace the pilot hood, tightening the pilot hood until it is snug (do not over-tighten).

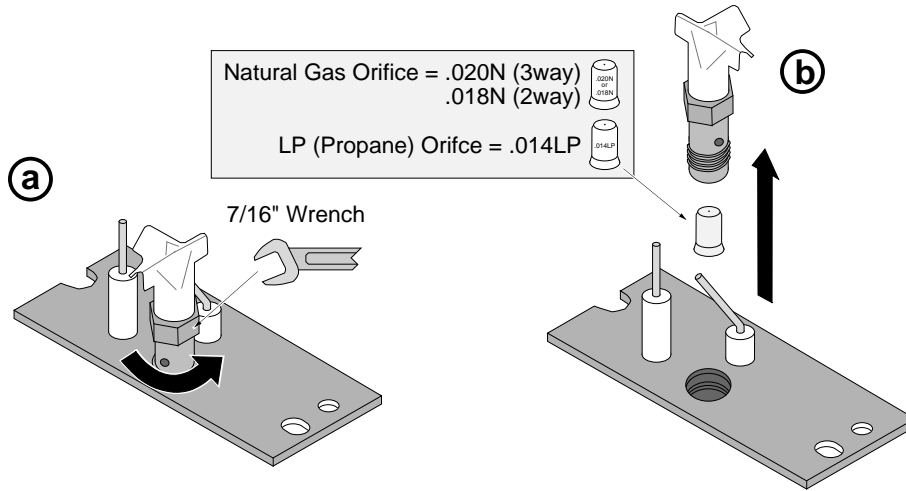

6. Remove the burner orifice and discard. Install the LP (propane) orifice.

(a) Remove the manifold cover to allow access to the burner orifice.

Then slide the air shutters to provide additional room.

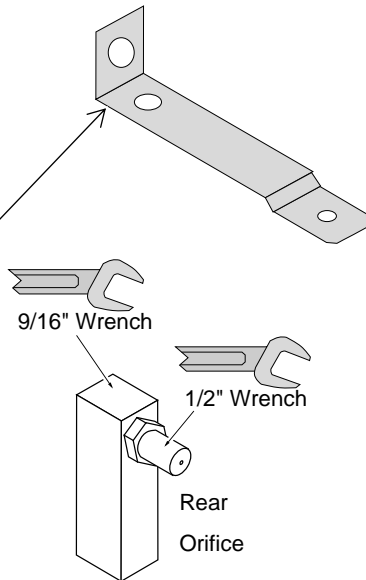
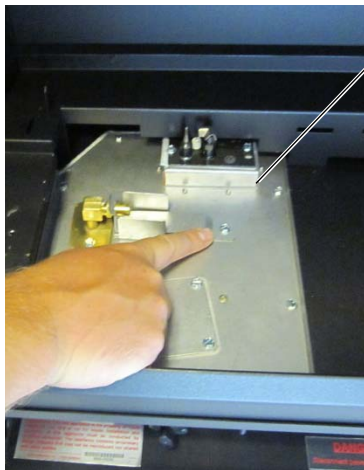

(b) Use a 9/16" wrench to secure the manifold while removing the orifice with a 1/2" wrench.

(c)

Apply thread sealant to the LP orifice prior to installation. Use the chart below to identify the correct orifices.

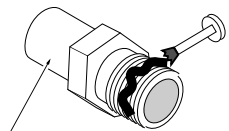

Look here for the orifice identification

(d)

Screw the LP orifice until orifice protrudes 15/16" (23.8mm) indicating full insertion (use wrench to secure manifold when re-attaching orifice).

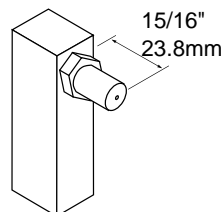

LP	NG
#52	#35

- Remove the cover plate and gasket over the low rate screw.

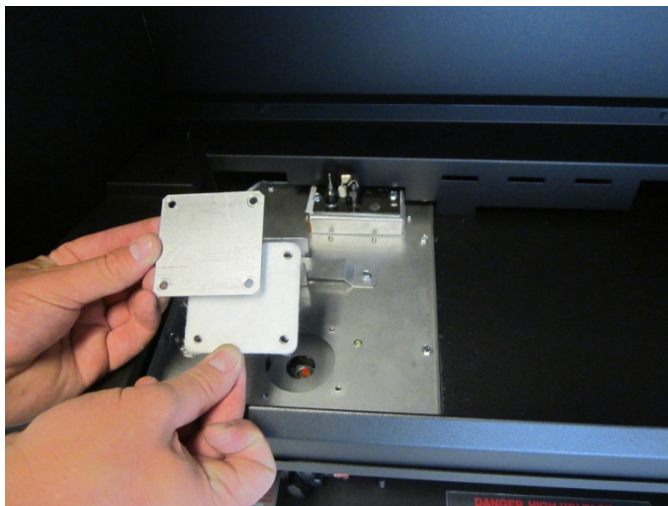
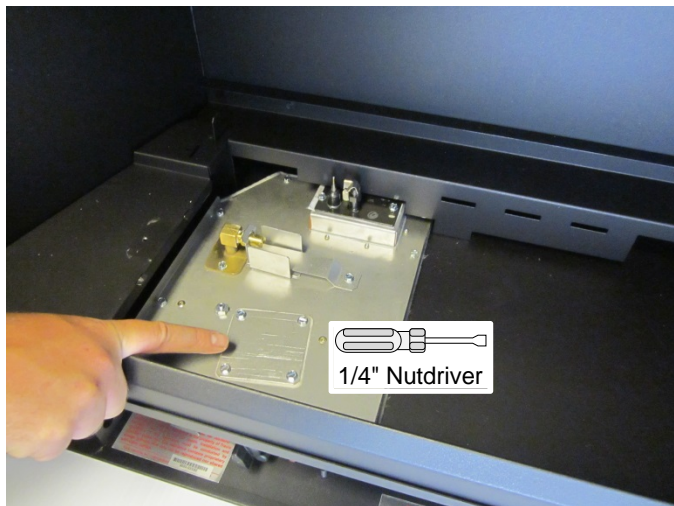

- Remove the low rate screw and discard. Install the LP (propane) low rate screw (1.3mm – stamped “130” near the base) – make sure it screws in all the way. Replace the cover plate and screws.  
**HINT: Unscrew the rate screw until it becomes loose. Then move it back and forth slightly until it moves to the side. Then use needle-nose pliers to remove the rate screw.**

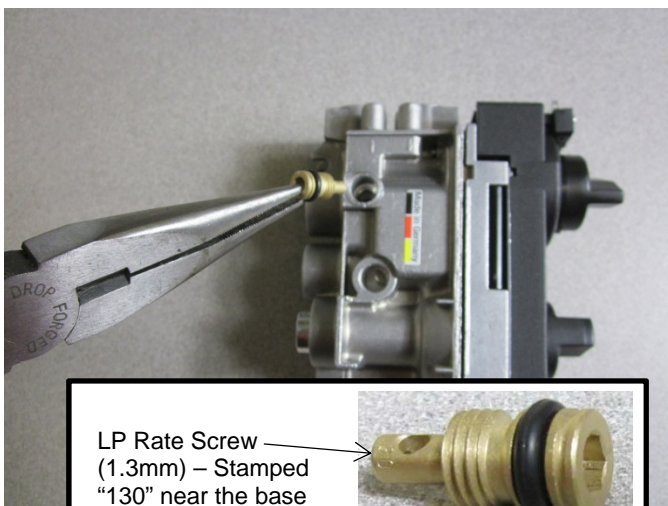
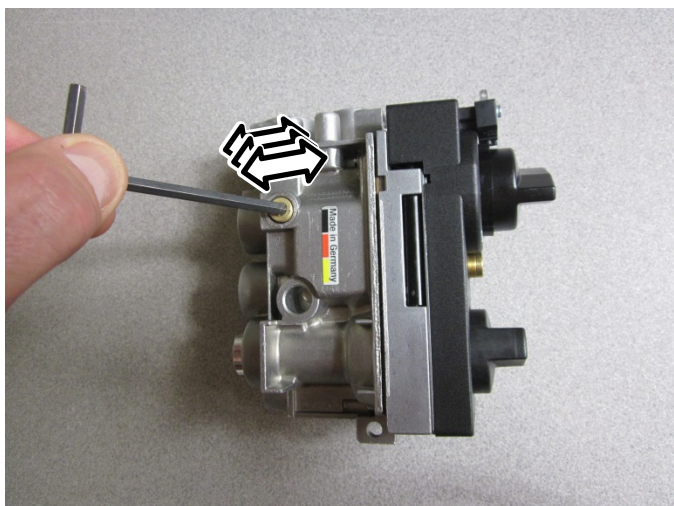
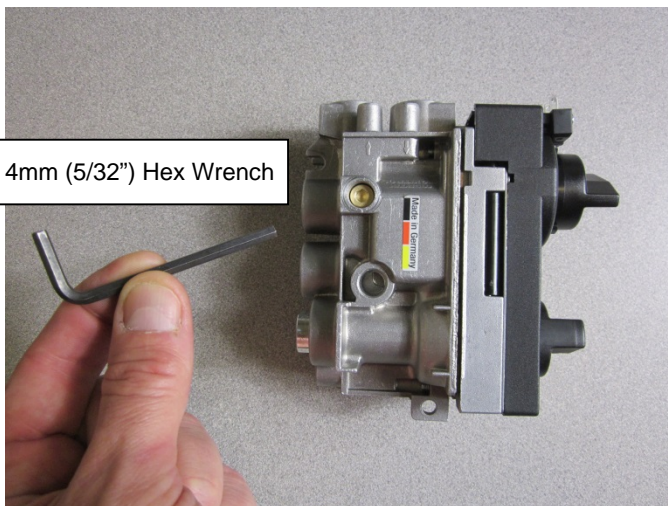
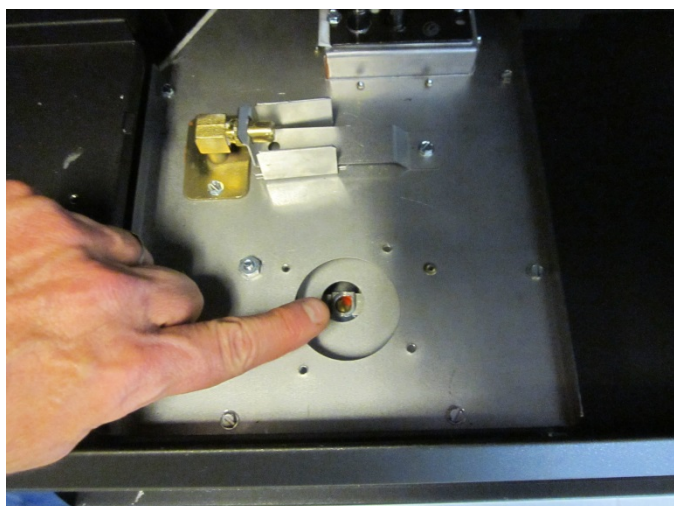

# 46

## Optional Equipment (for qualified installers only)

9. Unscrew the conversion plug on the front of the valve using a ¼" flat-head screwdriver (see pictures below). Carefully unsnap the plastic cap on the inward end of the conversion plug. Rotate the plug 180° and re-attach it to the conversion plug. Screw the conversion plug back into the gas control valve – **do not overtighten the conversion plug – it is not a gas seal.**

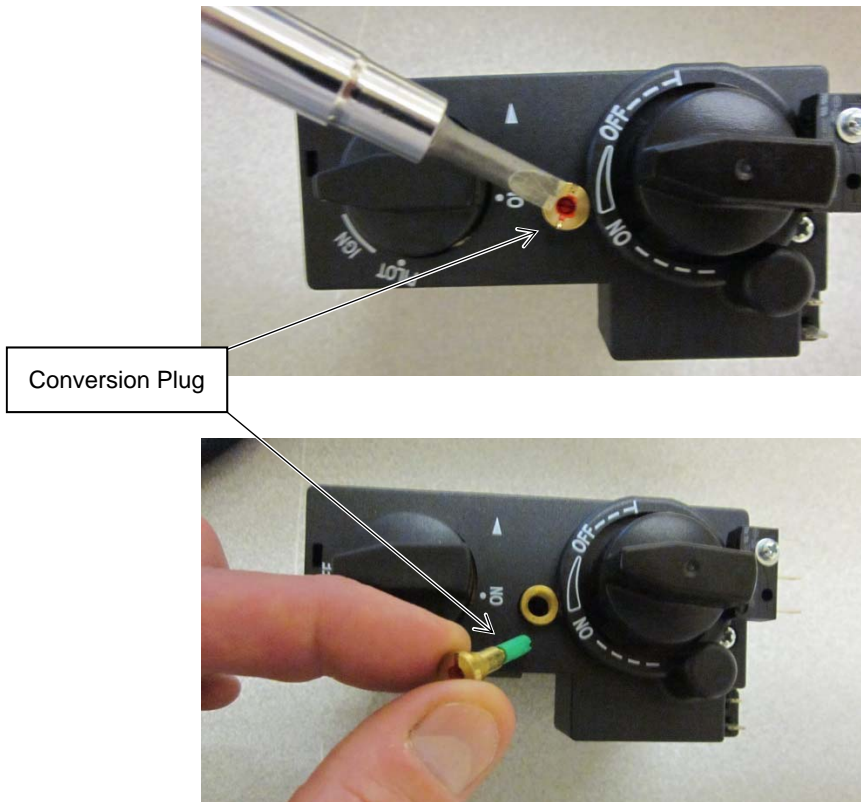

Carefully unsnap the plastic cap on the inward end of the conversion plug. Rotate the plug 180° and re-attach it to the conversion plug. Screw the conversion plug back into the gas control valve – **do not overtighten the conversion plug.**

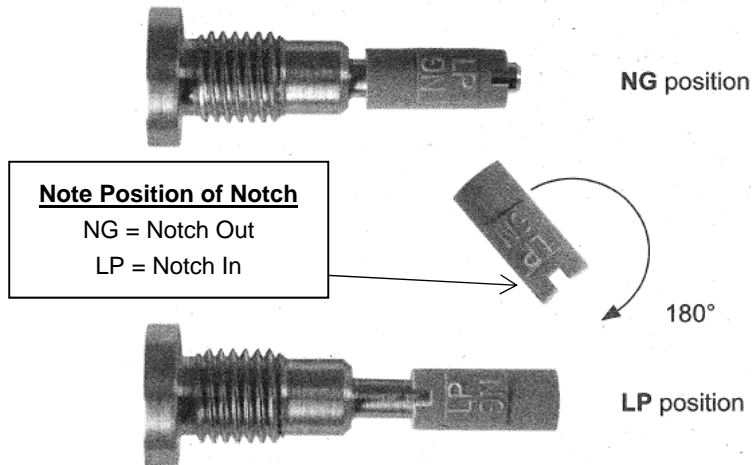

10. Replace the firebox components.
11. Restore the appliance to the correct configuration. Make the gas line connection, bleed the gas line (if applicable), start the heater and thoroughly leak-test all gas connections and the gas control valve.

## Optional Firebacks

**WARNING** Turn off gas to the appliance and make sure it has fully cooled prior to conducting service.

- 1 Remove the glass frame and logs (see the manual for details).
- 2 Remove the fireback clips and install the rear fireback following the directions to the right.

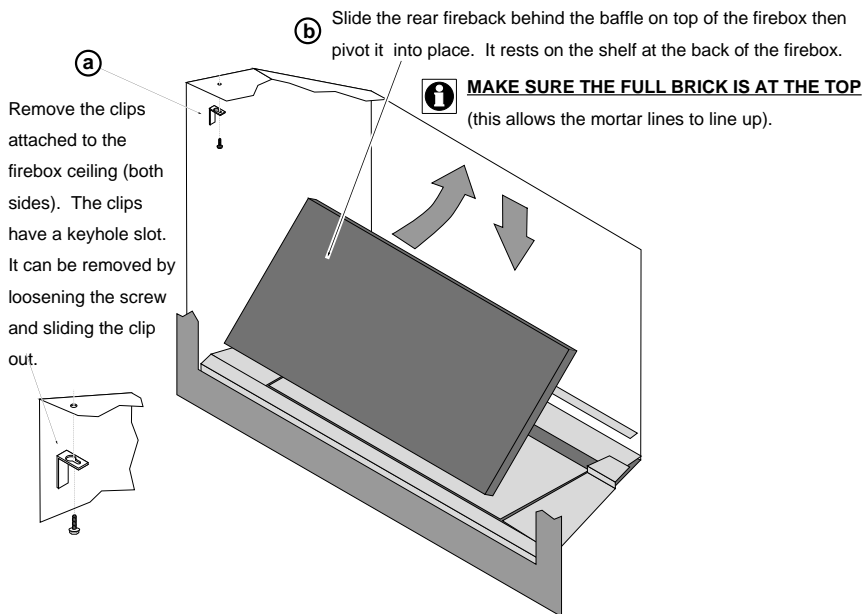

- 3 Install the side firebacks following the directions to the right.

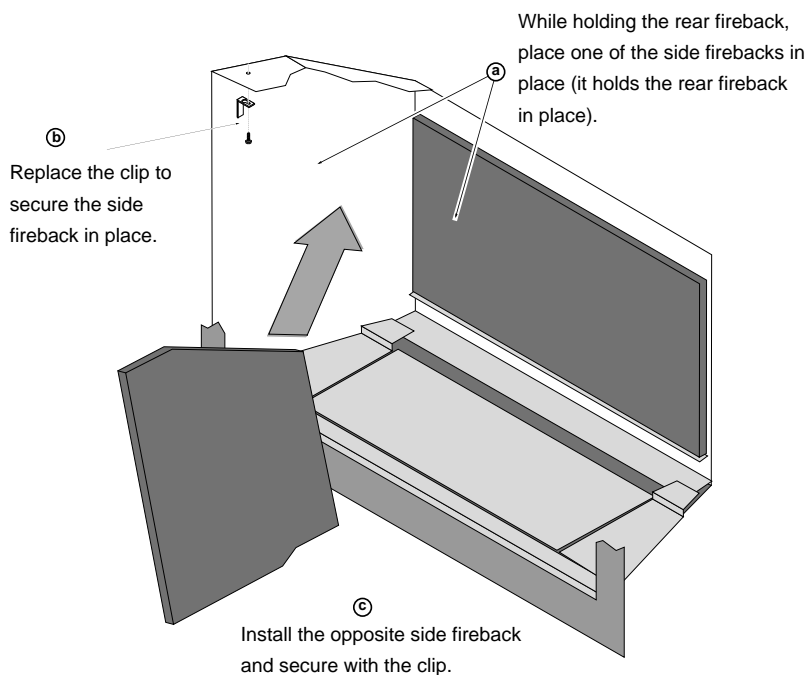

<b><i>Additional Items Required</i></b> .....	7	LP Conversion Instructions.....	43
Battery Replacement.....	38	Maintaining Your Heater's Appearance .....	38
Before You Begin .....	31	Normal Operating Odors.....	37
Clearances .....	11	Normal Operating Sounds .....	37
Dimensions .....	6	<b><i>Order of Installation</i></b> .....	7
Electrical Requirements for Optional Blower ...	10	<b><i>Packing List</i></b> .....	7
Features .....	6	Power Outages .....	37
Fireplace Requirements .....	8	<b><i>Remote Control Operation</i></b> .....	33
Fuel .....	6	Replacement Parts List.....	40
Gas Line Requirements .....	12	Rock Wool Placement .....	28
Glass Frame Removal and Installation .....	21	<b><i>Starting the Heater for the First Time</i></b> .....	32
Hearth Requirements .....	9	Starting the Pilot.....	32
Heating Specifications.....	6	Steps for Finalizing the Installation .....	29
Installation Options.....	6	Surround Panel Installation.....	20
Installation Warnings.....	7	Vent Requirements .....	13
Leveling Legs .....	10	Wiring Diagram .....	40
Location of Controls .....	31	Yearly Service Procedure .....	39
Log Installation .....	24		